

Caplio* R6

RICOH

Camera User Guide

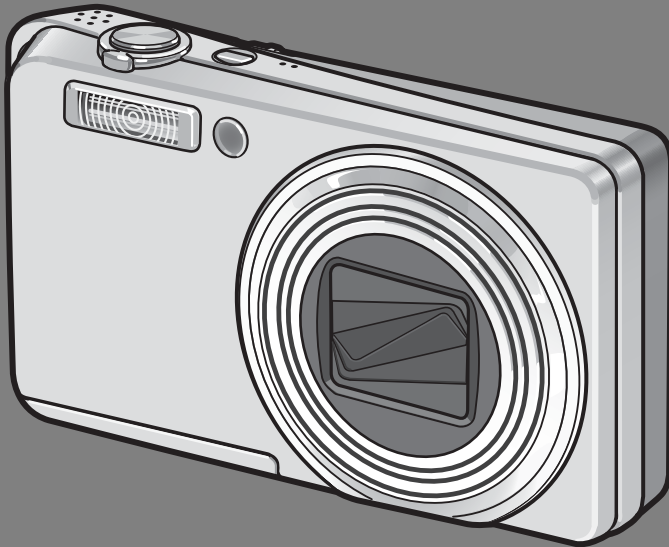

The serial number of this product is given on the bottom face of the camera.

Basic Operations

If you are using the camera for the first time, read this section.

This section provides a basic overview of how to turn on the camera, take pictures and play back pictures.

Advanced Operations

Read this section when you want to learn more about the different camera functions.

This section provides more detailed information about the functions used to take pictures and play back pictures, as well as information on how to customize the camera settings, print pictures, and use the camera with a computer.

Note

Do not connect the USB cable yet!

If you connect the camera to a computer through the USB cable before installing the provided software on the computer, the software required for connection between camera and computer may not be installed correctly. Be sure to connect the camera to your computer after installing the provided software. (👉 P.149)

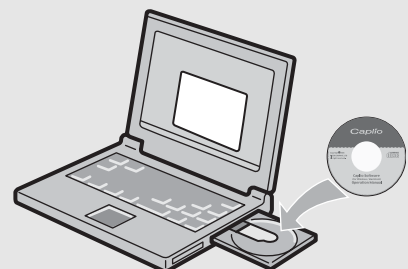

Preface

This manual provides information on how to use the shooting and playback functions of this product, as well as warnings on its use.

To make the best use of this product's functions, read this manual thoroughly before use. Please keep this manual handy for ease of reference.

Ricoh Co., Ltd.

Safety Precautions	For the safe use of your camera, be sure to read the safety precautions thoroughly.
Test Shooting	Please be sure to do some test shooting to make sure it is recording properly before normal use.
Copyright	Reproduction or alteration of copyrighted documents, magazines, music and other materials, other than for personal, home or similarly limited purposes, without the consent of the copyright holder is prohibited.
Exemption from Liability	Ricoh Co., Ltd. assumes no liability for failure to record or play back images caused by malfunction of this product.
Warranty	This product is manufactured to local specifications and the warranty is valid within the country of purchase. Should the product fail or malfunction while you are abroad, the manufacturer assumes no responsibility for servicing the product locally or bearing the expenditure incurred thereof.
Radio Interference	Operating this product in the vicinity of other electronic equipment may adversely affect the performance of both devices. In particular, operating the camera close to a radio or television may lead to interference. If interference occurs, follow the procedures below. <ul style="list-style-type: none">• Move the camera as far away as possible from the TV, radio or other device.• Reorient the TV or radio antenna.• Plug the devices into separate electrical outlets.

This publication may not be reproduced in whole or in part without the express written permission of Ricoh.
© 2007 RICOH CO., LTD. All rights reserved.

The contents of this document may be changed in the future, without prior notice.

This booklet was created with thorough attention to its content. If, however, you have a question, spot an error, or find a description lacking, please refer to the end of this booklet for information on how to contact us.

Microsoft, MS and Windows are registered trademarks of Microsoft Corporation in the United States of America and other countries.



Macintosh, Power Macintosh, and Mac OS are registered trademarks of Apple Inc. in the United States of America and other countries.

Adobe and Adobe Acrobat are trademarks of Adobe Systems Incorporated.

All trademarked company and product names mentioned in this manual are the property of their respective owners.

Using the Manuals

The following two manuals are included with your Caplio R6.

	<p>“Camera User Guide” (This booklet)</p> <p>This guide explains the usage and functions of the camera. It also explains how to install the provided software on your computer.</p> <p>* The “Camera User Guide” (English edition) is available from the provided CD-ROM as a PDF file.</p>
	<p>“Software User Guide” (PDF file)</p> <p>This guide explains how to download images from the camera to your computer and display and edit them on your computer.</p> <p>* The “Software User Guide” is available in the following folders on the provided CD-ROM.</p> <div style="display: flex; align-items: center; margin-top: 10px;"> <div style="flex: 1;"> <p>Each language has its own “Software User Guide” in the respective folder.</p> </div> <div style="flex: 2;">  </div> </div> <p>“Camera User Guide” (English edition) (PDF file)</p> <p>To copy the Software User Guide onto your hard disk, copy the PDF file from the respective folder directly to your hard disk.</p>

The camera is provided with the Irodio Photo & Video Studio software that allows you to display and edit images on your computer. For how to use Irodio Photo & Video Studio, see the displayed “Help”.

For more information on Irodio Photo & Video Studio, contact the Customer Support Center below.

- | | |
|--------------------------------|----------------------------------|
| North America (U.S.) | TEL: (Toll Free) +1-800-458-4029 |
| Europe | |
| UK, Germany, France and Spain: | TEL: (Toll Free) +800-1532-4865 |
| Other Countries: | TEL: +44-1489-564-764 |
| Asia | TEL: +63-2-438-0090 |
| China | TEL: +86-21-5450-0391 |

Business hours: 9:00 AM to 5:00 PM

Key Features

The illustrations in this manual may differ from the actual product.

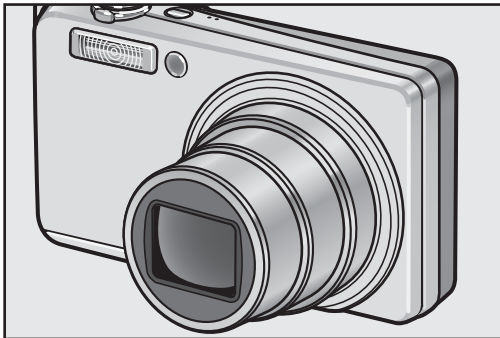

Equipped with a high magnification 7.1× wide angle zoom lens

This camera has a compact body, featuring a 28-mm* (Wide-angle) to 200-mm* (Telephoto) 7.1× optical zoom lens that covers a wide range of shooting. This lens can be used to take pictures in various indoor and outdoor situations.

*Equivalent to that on a 35mm camera



Camera shake correction function reduces blurring (P.93)

The camera comes with a camera shake correction function to allow you to take clearer pictures with minimized blurring even indoors, at night and in other situations where camera shake may occur.

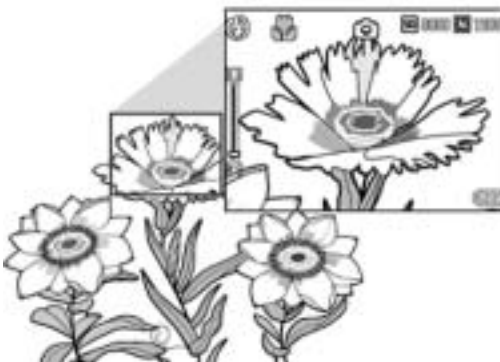

Macro shooting at 1 cm (P.36) and close-up flash shooting at 25 cm (Telephoto) or 20 cm (Wide-angle) (P.37)

The unsurpassed macro shooting function allows you to capture details from a very close distance at only 1 cm.

The camera also has a built-in flash for close-up shots at 25 cm (Telephoto) or 20 cm (Wide-angle). This combination gives you clear macro shots even under low light conditions.



Face recognition mode enables optimal shooting of the subject's face (P.39)

The camera automatically focuses on the subject's face and adjusts the exposure and white balance to the optimal settings.

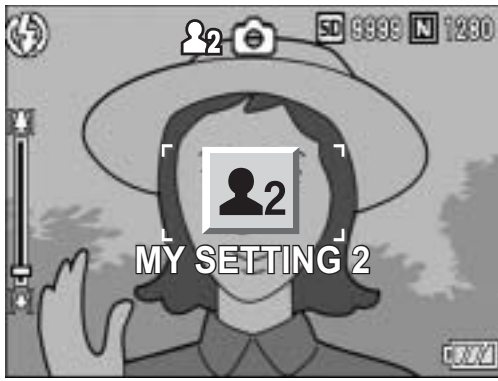

Easily customize your favorite shooting settings with My Settings mode (P.38)

You can customize two groups of settings, and then switch the mode selector to MY to easily shoot with either group of registered settings.

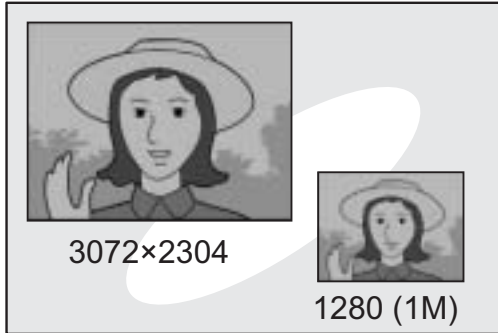

Use the dual size recording function to capture the image at two different sizes (P.94)

Each time you shoot an image with this function, you can record the still image at the original size and a smaller subfile at the same time.

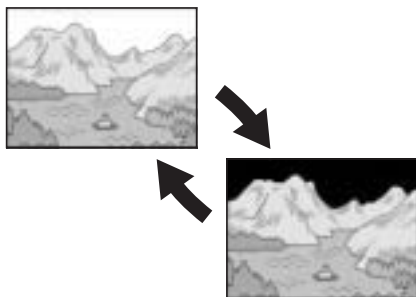

White saturation highlights display function (P.56)

Press the DISP. button during quick review or in playback mode to switch to the white saturation highlights display screen so you can check the white saturation highlights in the shot image.

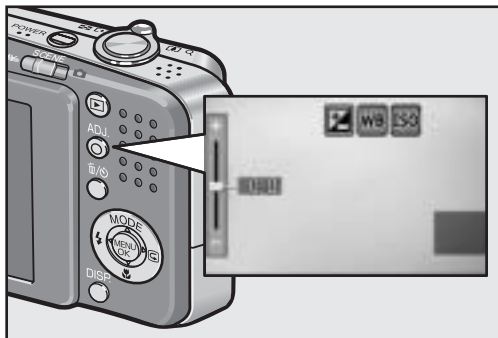

ADJ. (Adjust) button enables easier camera operations (P.60)

The ADJ. button simplifies the camera setting procedures. It allows you to make adjustments with minimum steps for settings, such as the exposure compensation and white balance. You can also assign a function as required.

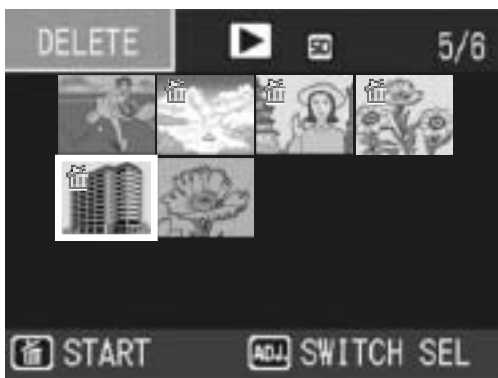

Easier deletion of multiple files (P.52)

You can easily delete unnecessary files by specifying a range of files to be deleted.



30 fps or 15 fps high-quality movies with sound (P.96)

Record high-quality movies with 640 × 480 pixels at 30 frames per second and with full sound.



Skew correction mode helps straighten skewed images (P.40)

In skew correction mode, a rectangular object shot at an angle can be straightened to look as if it were shot squarely. With the simple touch of a button, you can straighten skewed images of objects such as a message board, a display panel, or a name card.

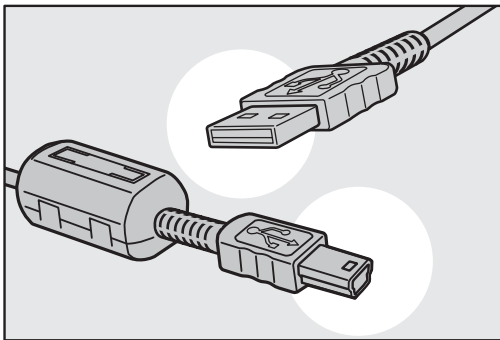

USB cable enables instant transfer of camera data to a computer

Install the provided software on your computer and then simply connect the camera to your computer with the provided USB cable to automatically transfer images to your computer.



Irodio Photo & Video Studio software for browsing, viewing, and editing still images and movies (P.150)

This bundled software enables you to view, organize, and edit shot images. You can also use the video editor function to create movies using still images, video clips, audio, and music files.

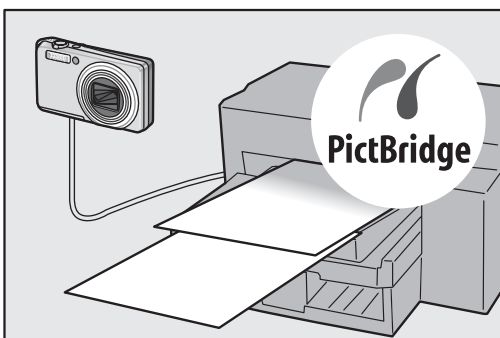

Direct printing without the use of a computer (P.115)

A Direct Print-compatible printer can be connected to the camera with the USB cable to directly transfer images to the printer. This allows for easy printing without using a computer. You can also print reports.

Contents

Using the Manuals	1
Key Features	2
Contents	5

Basic Operations

11

If you are using the camera for the first time, read this section.

Packing List	12
Names of Parts	14
How to Use the Mode Selector	16
LCD Monitor Display	17
Getting Ready	20
About the Battery	20
SD Memory Card (available in stores)	21
Charging the Rechargeable Battery	23
Loading the Rechargeable Battery and SD Memory Card	24
Turning the Power On/Off	26
Setting the Language	27
Setting the Date and Time	28
Basic Shooting	29
Holding the Camera	29
Shooting	31
Using the Zoom Function	35
Shooting Close-Ups (Macro Shooting)	36
Using the Flash	37
Shooting with My Settings Mode	38
Shooting with Optimal Settings According to Shooting Conditions	39
☺ Using the Self-Timer	44
Playing Back Images	45
Reviewing the Image You Just Took (Quick Review)	45
Viewing Your Images	46
Three-frame View/Grid View (Thumbnail Display)	48
Magnifying Images	50
Deleting Files	51
Deleting a File	51
Deleting All Files	52
Deleting Multiple Files at One Time	52
Changing the Display with the DISP. Button	55
Maximizing the LCD Monitor Brightness	57
Histogram	57

Read this section when you want to learn more about the different camera functions.

1 Various Shooting Functions	60
Using the ADJ. Button	60
Settings by Mode	60
Changing the Text Density (Scene Mode)	61
Shifting the AF Target (Macro).....	62
Shooting Setting Menu	63
Using the Menu.....	65
Choosing Picture Quality Mode/Image Size (PIC QUALITY/SIZE).....	66
Changing the Focusing Mode (FOCUS).....	68
Manual Focus Shooting (MF).....	69
Changing the Light Metering (AE METERING)	71
Changing the Edge Quality of Still Images (SHARPNESS)	72
Shooting with Multi-Shot (CONT./S-CONT/M-CONT).....	73
Viewing an S-CONT or M-CONT Still Image in Enlarged Display Mode.....	76
Setting the Color Depth (COLOR DEPTH).....	77
Shooting Consecutively with Different Exposures (AUTO BRACKET)	78
Shooting Consecutively with Different White Balance (WB-BKT).....	79
Using Long Time Exposure (TIME EXPOSURE)	81
Shooting Pictures Automatically at Set Intervals (INTERVAL)	82
🎤 Shooting a Still Image with Sound (IMAGE WITH SOUND)	84
Inserting the Date into a Still Image (DATE IMPRINT).....	85
Changing the Exposure (EXPOSURE COMP.).....	86
Using Natural and Artificial Lighting (WHITE BALANCE).....	87
Setting the White Balance Manually (MANUAL SETTINGS).....	89
Changing the Sensitivity (ISO SETTING).....	90
Limiting the Shutter Speed (SLOW SHUTTER LMT)	92
Using the Camera Shake Correction Function to Prevent Camera Shake (CAMERA SHAKE COR).....	93
Shooting a Still Image with a Subfile (RECORD DUAL SIZE).....	94
Returning the Shooting Setting Menu Settings to their Defaults (RESTORE DEFAULTS)	95

2 Shooting/Playing Back Movies 96

📷 Shooting Movies	96
Setting the Frame Rate (FRAME RATE)	97
Playing Back Movies	99

3 Other Playback Functions 100

Playback Setting Menu	100
Using the Menu	100
Displaying Photos in Order Automatically (SLIDE SHOW)	101
Write-protecting Files (PROTECT)	102
Protecting a File	102
Protecting All Files	103
Protecting Multiple Files at Once	104
Using a Printing Service (DPOF)	105
Setting DPOF for the Displayed Still Image	105
Setting DPOF for All Still Images	106
Setting DPOF for Multiple Still Images	107
Changing the Image Size (RESIZE)	108
Copying the Contents of the Internal Memory to an SD Memory Card (COPY TO CARD)	109
Straightening Skewed Images (SKEW CORRECTION)	110
Restoring Deleted Files (RECOVER FILE)	112
Viewing on a Television	113

4 Direct Printing 115

Direct Print Function	115
Connecting the Camera to a Printer	116
Printing Still Images	117
Printing One or All Still Images	117
Printing Several Still Images	119

5 Changing Camera Settings 121

SETUP Menu	121
Using the SETUP Menu	122
Preparing the SD Memory Card (FORMAT [CARD])	124
Formatting the Internal Memory (FORMAT [INT. MEM.])	125
Adjusting the Brightness of the LCD Monitor (LCD BRIGHTNESS)	126
Registering Custom Settings (REG. MY SETTINGS)	127
Changing the Step Zooming Setting (STEP ZOOM)	129
Changing the ISO AUTO-HIGH Setting (ISO AUTO-HIGH)	130

Changing the Size for RECORD DUAL SIZE (SUB FILE SIZE)	131
Changing the Auto Power Off Setting (AUTO POWER OFF) ...	132
Changing the Beep Sound Setting (BEEP SOUND)	133
Changing the Beep Sound Volume (VOL. SETTINGS).....	134
Changing Image Confirmation Time (LCD CONFIRM.)	135
Assigning Functions to the ADJ. Button (ADJ. BTN. SET.).....	136
Changing the AF Auxiliary Light Setting (AF AUX. LIGHT).....	137
Using the Auto Resize Zoom (DIGITAL ZOOM IMG).....	138
Displaying a Settings Change Warning (SHTG STGS WARNG.).....	140
Enlarging Icon Display (ENLGE PHOTO ICON)	141
Changing the USB Setting (USB CONNECTION).....	142
Changing File Name Settings (SEQUENTIAL NO.)	144
Setting the Date and Time (DATE SETTINGS).....	146
Changing the Display Language (LANGUAGE/言語)	147
Changing the Playback Method for Viewing on TV (VIDEO OUT MODE).....	148

6 Downloading Images to Your Computer 149

For Windows	149
Using the Caplio Software CD-ROM.....	150
System Requirements for Using Caplio Software CD-ROM	152
Installing the Software Required for Handling the Camera and Images.....	153
Installing the DeskTopBinder Lite	155
Installing Other Software on Your Computer	157
Uninstalling the Software	158
Downloading Images to Your Computer	160
Downloading Images Without Using the Caplio Software.....	161
Using the Original Driver to Download Images	163
Disconnecting the Camera from Your Computer	165
For Macintosh.....	166
Downloading Images to Your Computer	166
Disconnecting the Camera from Your Computer	167

7 Appendices 168

Troubleshooting.....	168
Error Messages.....	168
Camera Troubleshooting	169
Software and Computer Troubleshooting	174
Specifications	176
Number of Images That Can be Stored in Internal Memory/ SD Memory Card.....	178
Optional Accessories.....	179
Functions Whose Defaults are Restored When Camera is Turned Off	180
About Scene Mode	182
Shooting Setting Menu Items by Scene Mode.....	183
Using Your Camera Abroad	184
Cautions on Use.....	185
Care and Storage	186
Warranty and Servicing	187
Index.....	189

Basic Operations

If you are using the camera for the first time, read this section.

Packing List.....	12
Names of Parts.....	14
How to Use the Mode Selector	16
LCD Monitor Display	17
Getting Ready	20
Basic Shooting.....	29
Playing Back Images	45
Deleting Files	51
Changing the Display with the DISP. Button	55

Packing List

Open the package and make sure all the items are included.

Caplio R6

The serial number of the camera is provided on the bottom face of the camera.

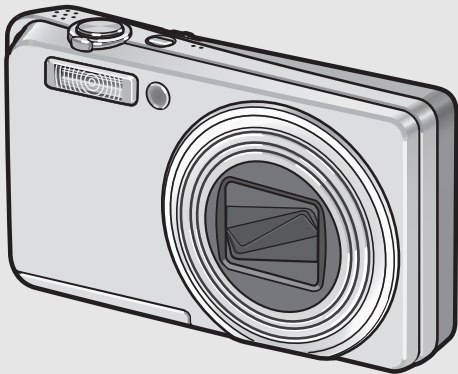

Rechargeable Battery

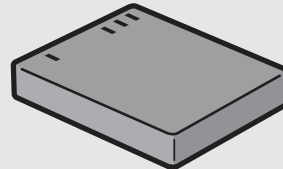

Battery Charger

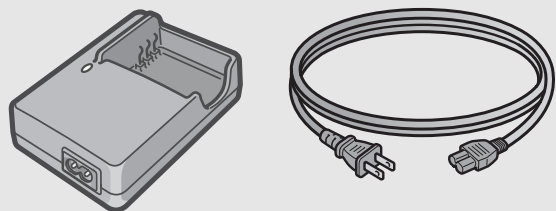

AV Cable

Used to view your images on a TV.

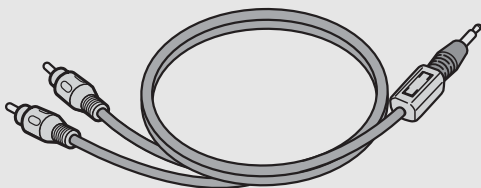

USB Cable (Mini B cable)

Used to connect the camera to a computer or Direct Print-compatible printer.

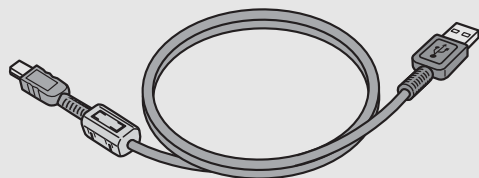

Handstrap

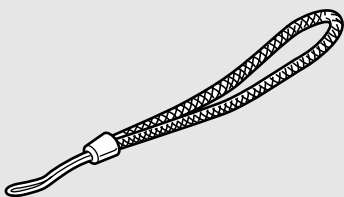

Note

Attaching the handstrap to the camera

Thread the small end of the strap through the strap eyelet on the camera and loop the ends as shown.

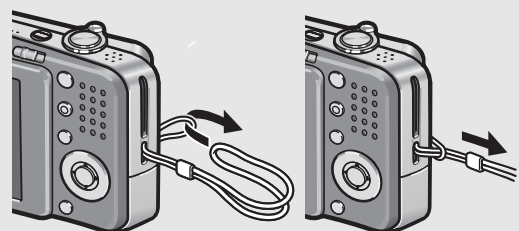

If you are using the camera for the first time, read this section.

Camera User Guide



(This booklet)

Warranty

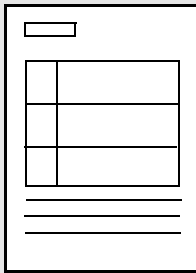

Safety Precautions



Caplio Software CD-ROM

The provided software and the "Software User Guide" are included on this CD-ROM.



Note

For the latest information about accessories, visit the Ricoh website at <http://www.ricohpmmc.com>.

Optional Accessories

Rechargeable Battery (DB-70)

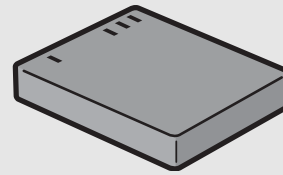

Battery Charger (BJ-7)

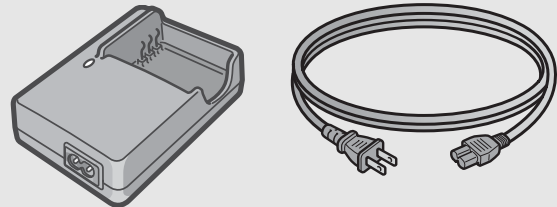

Soft Case (SC-70)

If you are using the camera for the first time, read this section.

Names of Parts

Camera

Front View

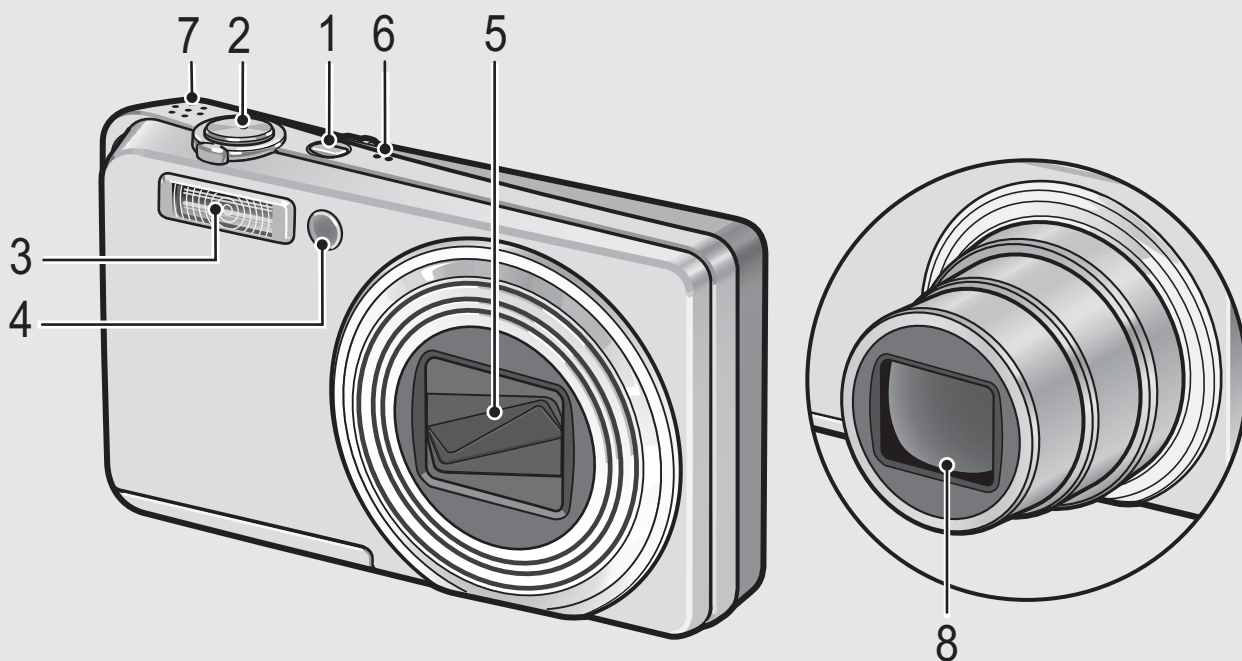

	Item Name	Refer to
1	POWER Button	P.26
2	Shutter Release Button	P.31
3	Flash	P.37
4	AF Auxiliary Light/Self-Timer Lamp	P.44, 137
5	Lens Cover	-
6	Microphone	-
7	Speaker	P.99
8	Lens	P.29

If you are using the camera for the first time, read this section.

Rear View

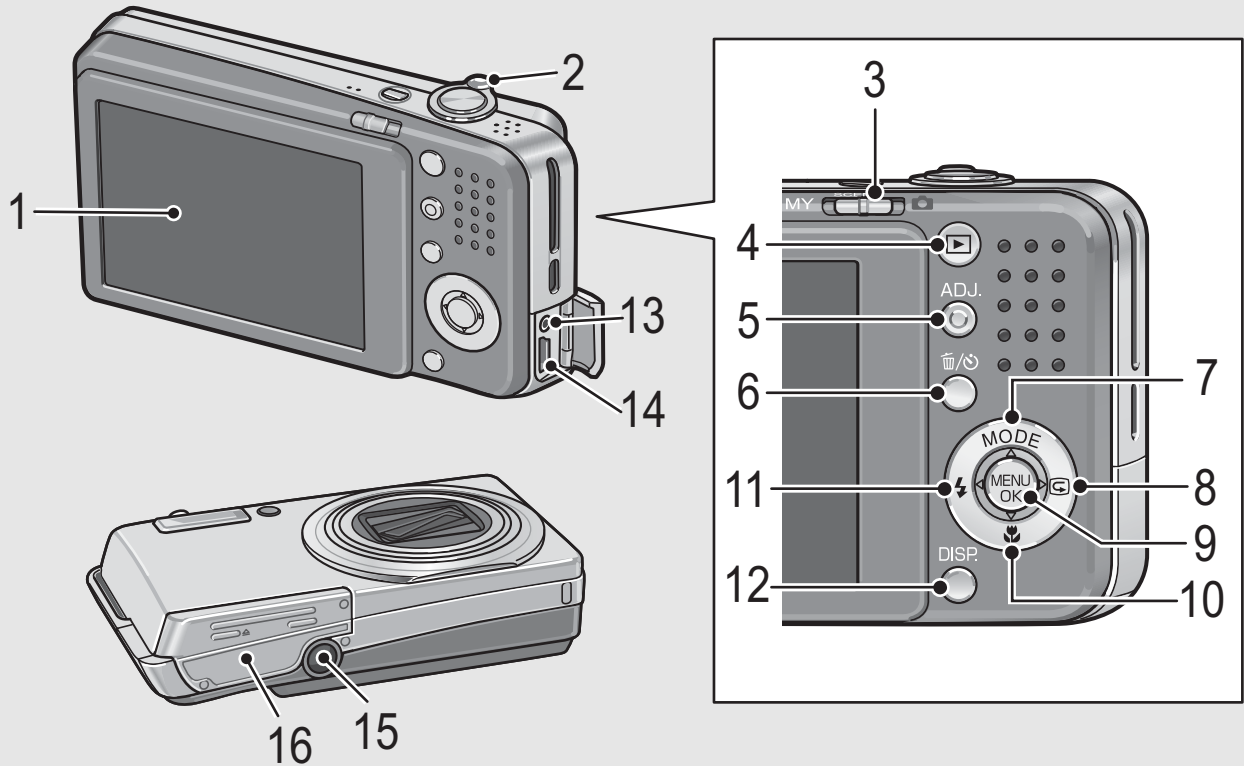

	Item Name	Refer to
1	LCD Monitor	P.17
2	Zoom lever [A] (Telephoto)/[W] (Wide-angle) Q (Enlarged View)/[T] (Thumbnail Display)	P.35, 48
3	Mode Selector	P.16
4	[▶] (Playback) Button	P.46
5	ADJ. Button	P.60
6	[🗑️] (Delete)/[⌚] (Self-timer) Button	P.51, 44
7	▲/MODE Button*	P.39
8	▶/[📷] (Quick Review) Button	P.45
9	MENU/OK Button	P.65, 100, 122
10	▼/[🌸] (Macro) Button	P.36
11	◀/[⚡] (Flash) Button	P.37
12	DISP. Button	P.55
13	AV Output Terminal	P.113
14	USB Terminal	P.116, 160
15	Tripod Screw Hole	P.176
16	Battery/Card Cover	P.24

* The MODE button is only available during scene mode or My Settings.

If you are using the camera for the first time, read this section.

How to Use the Mode Selector

Set the mode selector to the desired mode before shooting still images or movies.

- 1** Switch the mode selector to the symbol of the function you want to use.

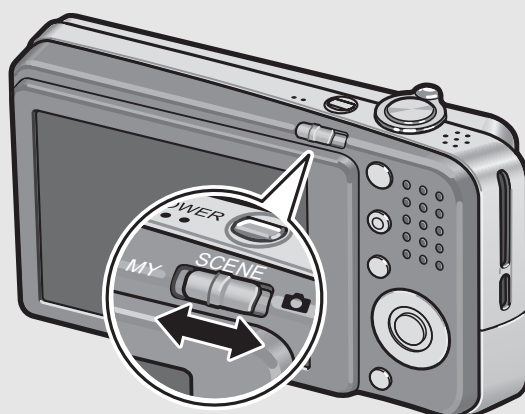

Mode Selector Symbols and Descriptions

Symbol	Function	Description	Refer to
MY	My Settings Mode	You can shoot using the settings registered in [REG. MY SETTINGS].	P.38
SCENE	Scene Mode	Allows you to shoot with settings optimized for the shooting scene. This also allows you to shoot movies with sound.	P.39
	Auto Shooting Mode	Allows you to shoot still images.	P.31

If you are using the camera for the first time, read this section.

LCD Monitor Display

Example of LCD Monitor Display when Shooting Pictures

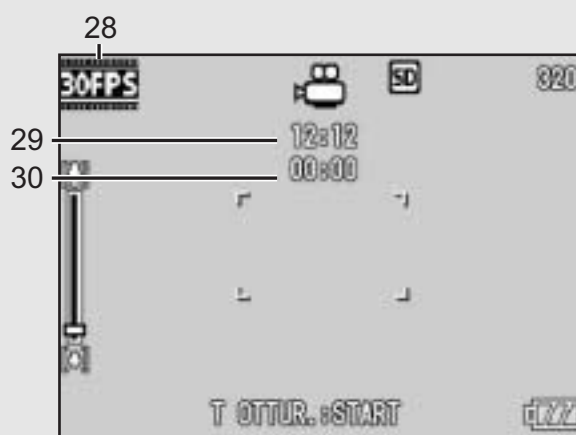

Movie Mode

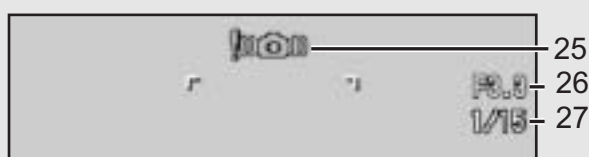

Still Image Mode

	Item Name	Refer to		Item Name	Refer to
1	Flash	P.37	16	Color Depth	P.77
2	Macro Shooting	P.36	17	Exposure Compensation	P.86
3	Self-timer	P.44	18	ISO Setting	P.90
4	Scene Modes	P.39	19	Date Imprint	P.85
5	Mode Types	P.16, 39	20	Interval	P.82
6	Recording Destination	P.21	21	Time Exposure	P.81
7	Remaining Number of Still Images	P.178	22	Histogram	P.57
8	Picture Quality	P.66	23	Camera Shake Correction	P.93
9	Image Size	P.66	24	Battery Mark	P.19
10	Zoom Bar	P.35	25	Camera Shake Warning Mark	P.30
11	Focus	P.68	26	Aperture Value	P.176
12	Auto Bracket	P.78	27	Shutter Speed	P.92
13	White Balance	P.87	28	Frame Rate	P.97
14	AE Metering	P.71	29	Remaining Recording Time	P.178
15	Sharpness	P.72	30	Recording Time	P.178

If you are using the camera for the first time, read this section.



Note -----

- The number of remaining shots available may differ from the actual number of shots, depending on the subject.
- Movie recording time and the maximum number of still pictures may vary depending on the capacity of the recording destination (internal memory or SD memory card), shooting conditions, and the type and manufacturer of the SD memory card.
- When the number of remaining shots is 10,000 or more, “9999” is displayed.

Example of LCD Monitor Display During Playback

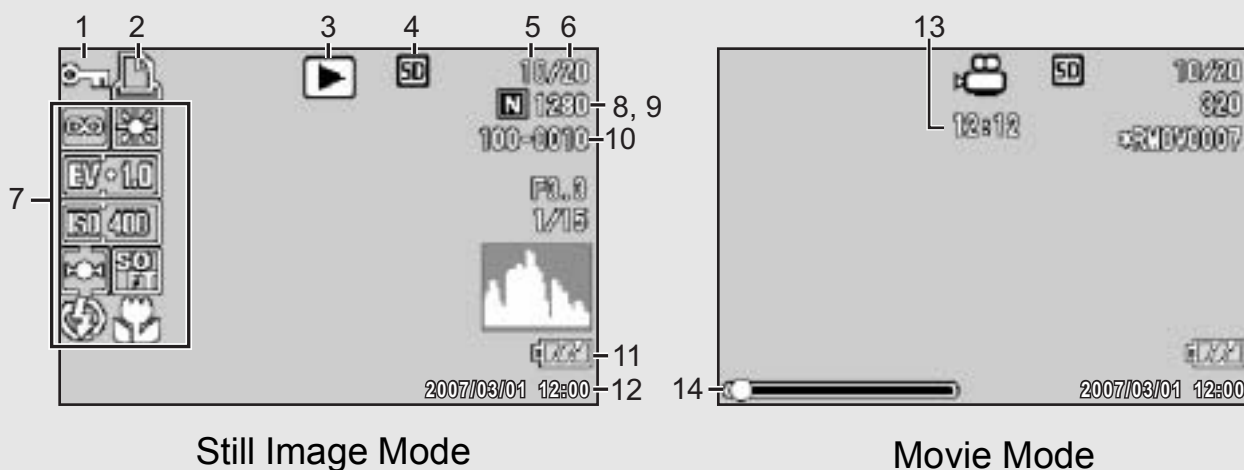

	Item Name	Refer to		Item Name	Refer to
1	Protect	P.102	8	Picture Quality	P.66
2	DPOF	P.105	9	Image Size	P.66
3	Mode Types	-	10	File No.	-
4	Playback Data Source	P.47	11	Battery Mark	P.19
5	Number of Playback Files	-	12	Date at Shooting	P.85, 146
6	Total Number of Files	-	13	Recording Time or Lapsed Time	-
7	Setting at Shooting (Recording)	-	14	Indicator	-





Note -----

The LCD monitor may display messages to inform you of operational instructions or the camera’s status while in use.

Battery Level Indication

A battery mark appears at the lower right of the LCD monitor to indicate the battery level. Recharge the battery before it is depleted.

Battery Mark	Description
 Green	The battery is sufficiently charged.
	The battery level begins to drop. Recharging is recommended.
	The battery level is low. Recharge the battery.

If you are using the camera for the first time, read this section.

Getting Ready

Turn the power on and get ready to shoot.



Note

- If you have already used this camera, make sure it is turned off before inserting or removing the battery.
- For information on how to turn the camera off, see P.26.

About the Battery

Rechargeable Battery DB-70 (supplied)

This is a lithium-ion battery. It is economical because you can recharge it using the battery charger and use it over and over again. The battery lasts a long time, so it is convenient when traveling.

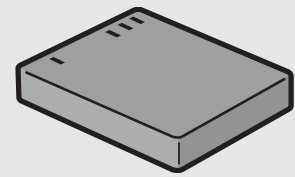

Number of shots you can take

Approximate number of shots you can take on a single charge: Approx. 310

- Based on CIPA standard (Temperature: 23 degrees Celsius, LCD monitor on, 30 seconds between shots, changing the zoom setting from telephoto to wide-angle or wide-angle to telephoto for each shot, 50% flash usage, turning the power off after each 10 shots).
- Set the camera to synchro-monitor mode to increase the number of shots you can take. (👉 P.55)
- The number of shots is for reference only. If the camera is used for long periods of time for setting and playback, the shooting time (the number of shots) will decrease.



Caution

- The battery may become very hot immediately after operation. Turn the camera off and leave it to cool down sufficiently before removing the battery.
- Please remove the batteries if you are not going to use the camera for a long period of time.
- When using a lithium-ion battery, use only the specified rechargeable lithium-ion battery (DB-70). Do not use other rechargeable lithium-ion batteries.

If you are using the camera for the first time, read this section.

SD Memory Card (available in stores)

You can store still images you have taken either in the camera's internal memory or on an SD memory card (available in stores). The internal memory capacity is 54 MB.

To record a lot of still images or movies at high resolutions, use a high-capacity SD memory card.



Where images are recorded-----

When no SD memory card is loaded, the camera records images to the internal memory; when an SD memory card is loaded, it records images to the SD memory card.

When no SD memory card is loaded

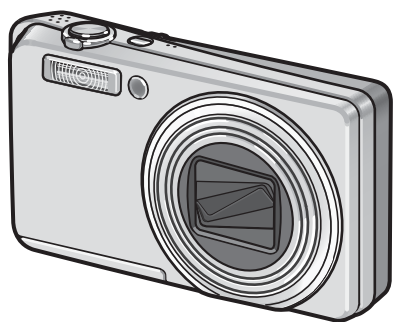

Records to the internal memory

When an SD memory card is loaded

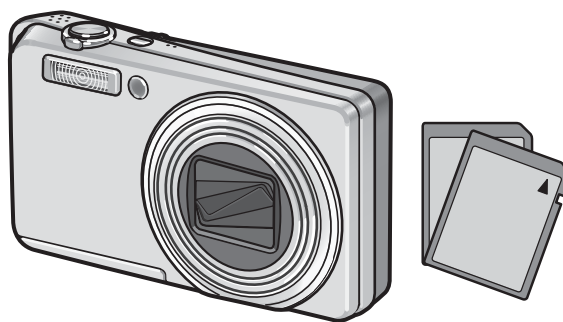

Records to the SD memory card



Caution-----

- If an SD memory card is loaded, the camera does not record to the internal memory, even if the card is full.
- Take care not to get the contacts of the card dirty.



Write-protecting your images -----

Move the write-protection switch on the SD memory card to LOCK to prevent your still images from being accidentally erased or the card from being formatted. If you unlock the card (by returning the switch to its original position), it is once again possible to erase images and format the card.

It is recommended to move the write-protection switch to LOCK when you have some important data recorded.

Note that you cannot shoot images on a locked card because no data can be recorded to the card. Unlock the card before shooting.

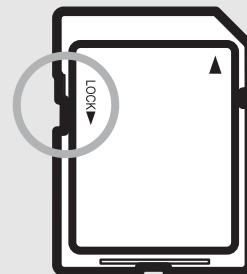

If you are using the camera for the first time, read this section.



Note

- For information on switching between the SD memory card and internal memory during playback, see P.47.
- Movie recording time and the maximum number of still pictures varies depending on the capacity of the SD memory card. (👉 P.178)
- Before using a new SD memory card, be sure to format it with this camera. (👉 P.124)
- When using an SD memory card previously used with another camera, be sure to back up any necessary data on the card before formatting it. (👉 P.124)
- SDHC memory card (4 GB) can also be used.

Charging the Rechargeable Battery

The rechargeable battery needs to be charged before use. The battery is not charged at the time of purchase.

1 Insert the battery into the battery charger, making sure that the \oplus and \ominus markings on the battery match those on the battery charger.

- The battery label should face up.



Caution

Be careful not to reverse the \oplus and \ominus sides.

2 Plug the battery charger into an outlet.

- Use the battery charger (BJ-7) to recharge the battery.
- Charging starts, and the charger lamp indicates the progress, as shown below. Once charging has finished, unplug the power cable from the power outlet.

Charger Lamp	Description
Lit	Charging started
Off	Charging complete
Flashing	Battery charger or battery may be faulty (unplug the battery charger from the power outlet and remove the battery from the battery charger).

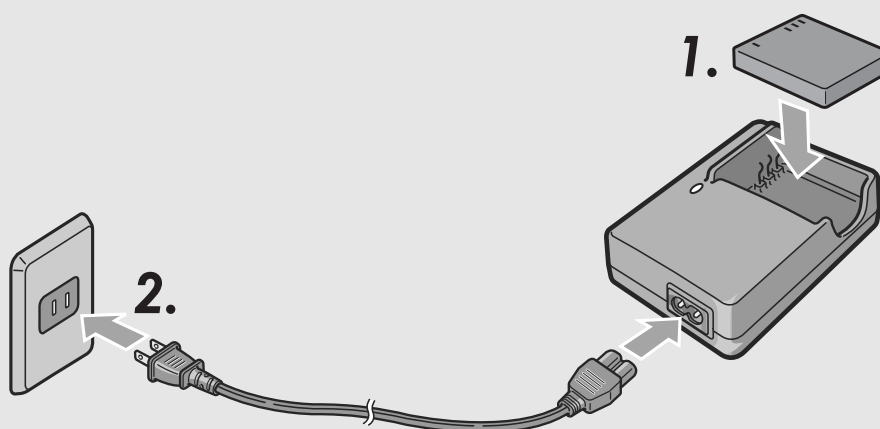

- Depending on the battery level, the charging time differs.

Rechargeable battery charging time	
DB-70	About 100 min. (25 °C)

If you are using the camera for the first time, read this section.

Loading the Rechargeable Battery and SD Memory Card

The rechargeable battery (DB-70) can be used to power this camera. This battery is convenient because the battery power lasts long and it can be used over and over again by recharging. If you have already used this camera, make sure it is turned off before loading the battery and card.

If you are using the camera for the first time, read this section.

1 Open the battery/card cover.

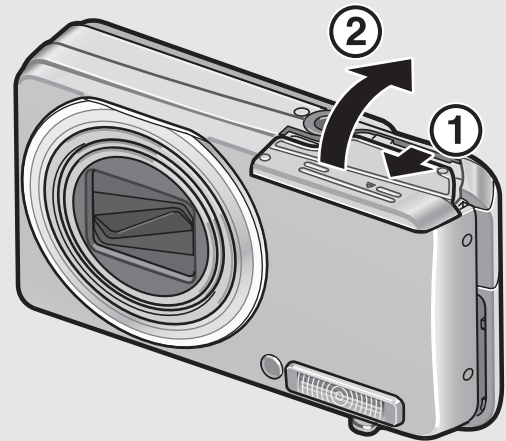

2 Make sure the SD memory card is facing the right way and then push the card all the way in until it clicks.

- The rechargeable battery may be inserted first.

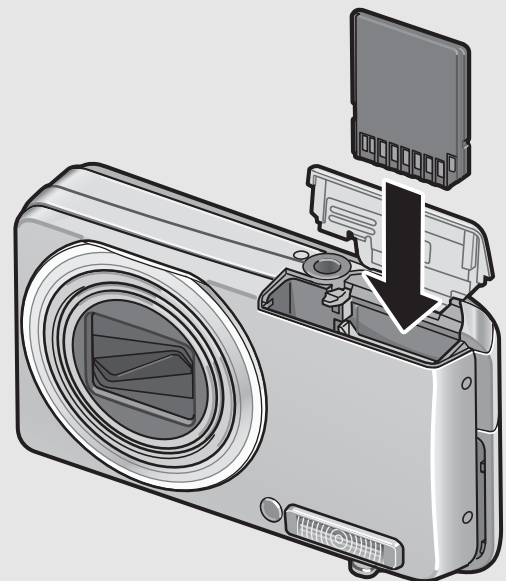

3 Insert the rechargeable battery.

- When the rechargeable battery is loaded in place, it is locked with the hook shown in the figure.

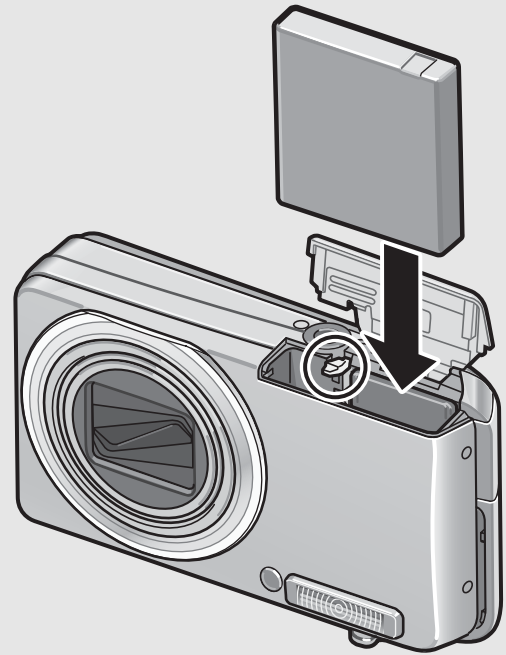

4 Close the battery/card cover and slide it back into place.

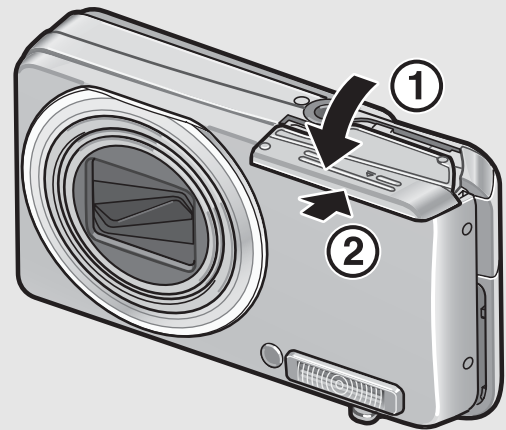

If you are using the camera for the first time, read this section.

Removing the Rechargeable Battery

Open the battery/card cover. Release the hook that locks the rechargeable battery. The battery is ejected. Pull the battery out of the camera. Be careful not to drop the battery when removing it from the camera.

Removing the SD Memory Card

Open the battery/card cover. Push in the SD Memory Card and gently release to eject it. Pull the card out of the camera.



Caution-----

Remove the batteries if you are not going to use the camera for a long period of time. Store the removed batteries in a dry cool place.

Turning the Power On/Off



To turn the power on:

1 Press the POWER button.

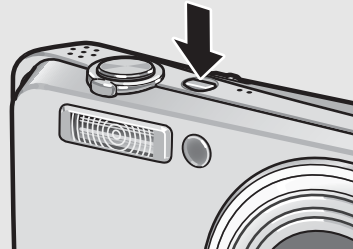
- After the start sound, the LCD monitor turns on.



Using the Camera in Playback Mode

- Pressing the  (Playback) button for more than one second turns on the camera in playback mode, allowing you to start playback at once.
- When the camera is turned on with the  (Playback) button, pressing the  (Playback) button again switches playback mode to recording mode.

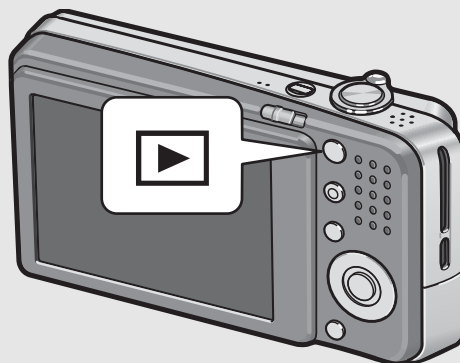

To turn the power off:

1 Press the POWER button.

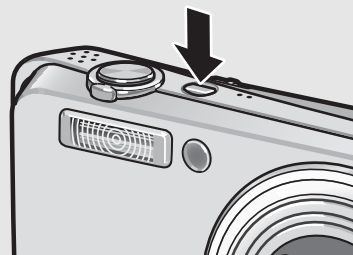

Caution-----

After the camera is turned on, it may take longer for the camera to become ready for shooting when using the flash than when not using the flash.



Auto Power Off-----

- If the camera goes unused for a set period of time, it automatically turns itself off to save power. (Auto Power Off)
- The auto power off setting can be changed. (👉 P.132)

If you are using the camera for the first time, read this section.

Setting the Language

When the power is turned on for the first time, the language setting screen appears (for the LCD monitor display language). After setting the language, go on to the date/time setting (for printing the date and time on your photos).

You can shoot without these settings. However, be sure to set the language, and the date/time later. Use the SETUP menu for these settings.

1 Turn the power on for the first time after purchase.

- The language selection screen appears.
- To skip language setting, press the MENU/OK button.
- When the MENU/OK button is pressed, the language setting is cancelled and the video signal format-setting screen appears.

2 Press the ▲▼◀▶ buttons to select a language.

3 Press the MENU/OK button.

- The display language is set, and the date/time setting screen appears.



Note

For how to set the display language and date/time on the SETUP menu, see “Changing the Display Language (LANGUAGE/言語)” (P.147) and “Setting the Date and Time (DATE SETTINGS)” (P.146) in this guide.

If you are using the camera for the first time, read this section.

Setting the Date and Time

When the power is turned on for the first time, the date/time setting screen appears.

1 Press the ▲▼◀▶ buttons to set the year, month, date and time.

- Change the value with ▲▼ and move the frame with ▶◀.

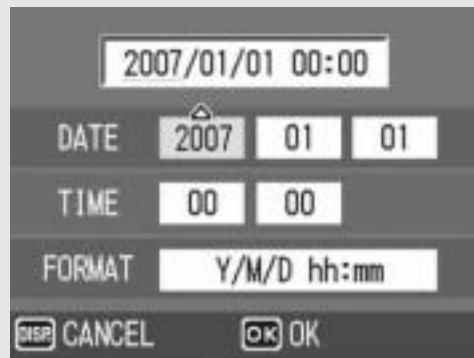

Setting at shipping

2 In [FORMAT], choose the date and time format.

- Select the date and time format with ▲▼.

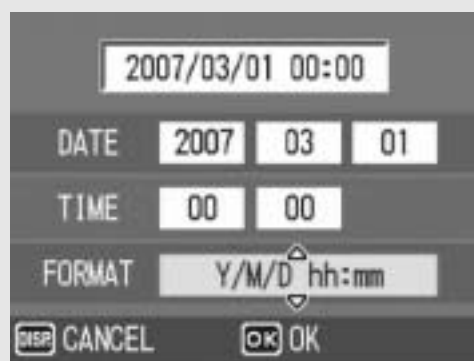

3 Check the display and then press the MENU/OK button.

- The date is set.
- Pressing the DISP. button on this screen allows you to cancel the setting.



Note

- If the battery is removed for more than one week, the date and time settings will be lost. These settings must be made again.
- To retain the date and time settings, load a battery with adequate remaining power for more than two hours.
- The set date and time can be changed later. (👉 P.146)
- The date and time can be inserted into images. (👉 P.85)

If you are using the camera for the first time, read this section.

Basic Shooting

Now you are ready.

Holding the Camera

Hold the camera as shown below for best results.

- 1** Hold the camera with both hands and lightly press both elbows against your body.



- 2** Put your finger on the shutter release button.

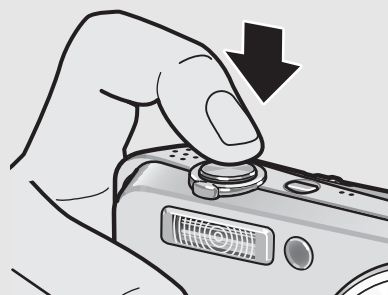

Caution

When you are shooting, be careful not to obstruct the lens or flash with your fingers, hair, or the strap.

If you are using the camera for the first time, read this section.



Preventing Camera Shake-----

If you move the camera when pressing the shutter release button, the still image might not come out clearly due to camera shake.

Camera shake tends to occur in the following cases:

- When shooting in a dark place without using the flash
- When using the zoom function
- When shooting using long time exposure (👉 P.81)

When the  mark appears on the LCD monitor, this indicates that camera shake may occur. To prevent camera shake, try any of the following.

- Using the camera shake correction function (👉 P.93)
- Setting the flash to [AUTO] or [FLASH ON] (👉 P.37)
- Raising the ISO setting (👉 P.90)
- Using the self-timer (👉 P.44)

If you are using the camera for the first time, read this section.

Shooting

The shutter release button works in two steps. You can press the shutter release button halfway down (half-press) and press it all the way down (full-press).

Quickly Shooting Pictures (Full-press)

Full-press the shutter release button for quick focusing, so as not to miss a shooting opportunity.

- 1** Press the **POWER** button to turn the camera on, and switch the mode selector to .



- 2** Compose your shot by looking at the LCD monitor, make sure the subject is centered, and gently press the shutter release button fully.

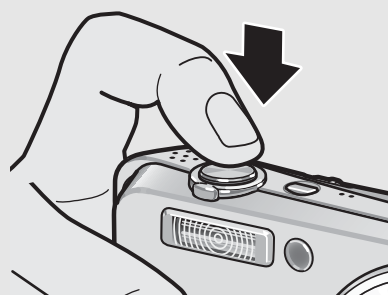

- The still image you have taken appears momentarily on the LCD monitor and is recorded to the internal memory or SD memory card.



Caution

Full-press is likely to cause the camera to shake. Hold the camera firmly with both hands and shoot. Turning the camera shake correction function on minimizes blurring due to camera shake. (👉 P.93)



Note

You can set the time the still image you have taken appears on the LCD monitor. You can also set the image not to appear after it is taken. (👉 P.135)

If you are using the camera for the first time, read this section.

If you are using the camera for the first time, read this section.

Checking the Focus and Shooting (Half-press/ Focus Lock)

When you press the shutter release button halfway (Half-press), the auto-focus function is triggered to determine the focal distance. Next, press it all the way down (Full-press) to shoot. When your subject is not in the center of your composition, compose your photo after focusing. (Focus Lock)

- 1** Press the **POWER** button to turn the camera on, and switch the mode selector to .

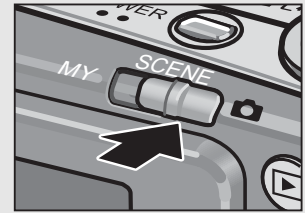

- 2** Put the subject of your photo in the center of the screen and press the shutter release button halfway.

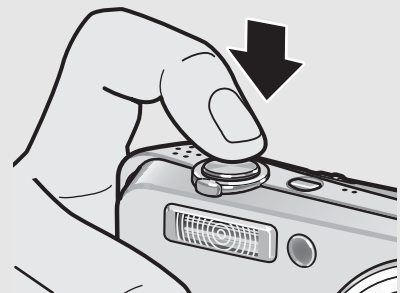

- The camera focuses on the subject and the exposure and white balance are fixed.
- If automatic focusing fails, the frame in the center of the LCD monitor turns red.
- The focal distance is measured at a maximum of five points. Green frames appear to indicate the positions that are in focus.

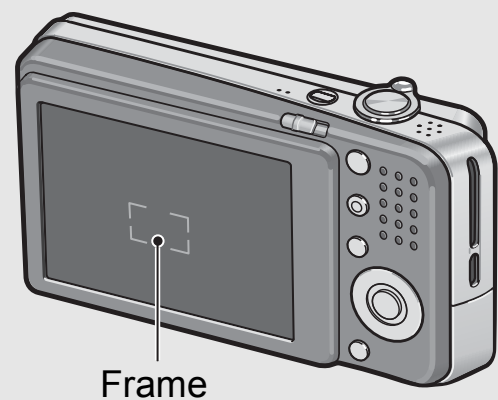

3 To take a picture with the subject in the foreground in focus against a background, half-press the shutter release button to focus on the subject, and then compose your shot.

Subject to be focused on

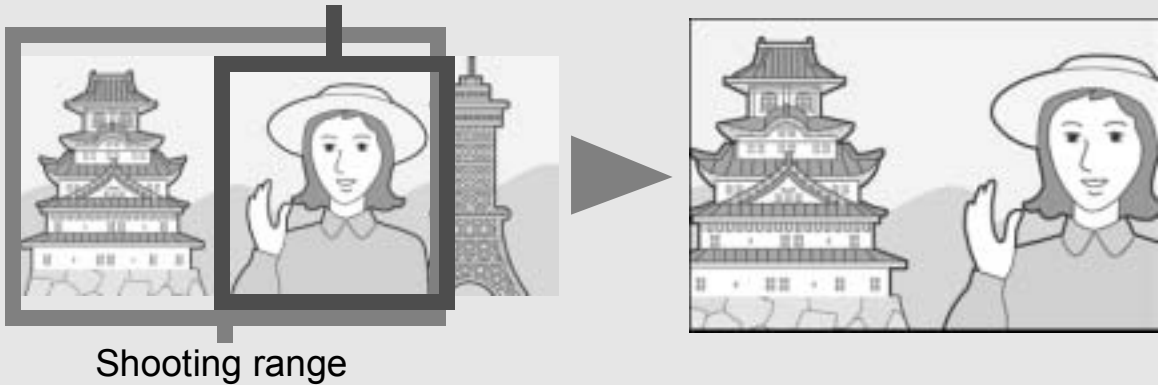

4 Gently press the shutter release button all the way.

- The still image you have taken appears momentarily on the LCD monitor and is recorded to the internal memory or SD memory card.

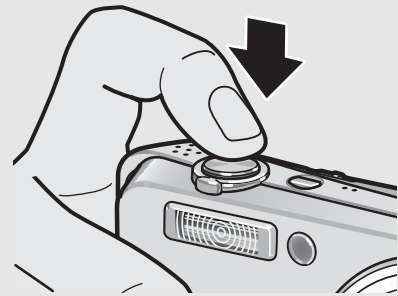

Focusing-----

The color of the frame in the center of the LCD monitor indicates whether the subject is in or out of focus.

Focus Status	Frame Color
Before focusing	White
Subject in focus	Green
Subject not in focus	Blinks (red)

- It may be impossible to bring the following subjects into focus.
 - Subjects lacking contrast (the sky, a white wall, the hood of a car, etc.).
 - Flat two-dimensional objects with only horizontal lines and no significant protrusions.
 - Quickly moving objects.
 - Things in poorly lit places.
 - Areas with strong backlighting, or reflections.
 - Things that flicker, such as fluorescent lights.

When you want to shoot subjects like this, first focus on an object the same distance as your subject and then shoot.

If you are using the camera for the first time, read this section.



Note

- Press the shutter release button gently to prevent camera shake.
- The  symbol indicates that camera shake may occur. Hold the camera still and focus the camera again. You can also turn on the camera shake correction function to minimize blurring. (👉 P.93)
- The auxiliary flash fires to increase the AE accuracy.

If you are using the camera for the first time, read this section.

Using the Zoom Function

Turning the zoom lever toward [▲] (Wide-angle) allows you to take a wide-angle picture.

Turning the zoom lever toward [▼] (Telephoto) allows you to take a close-up picture of the subject.

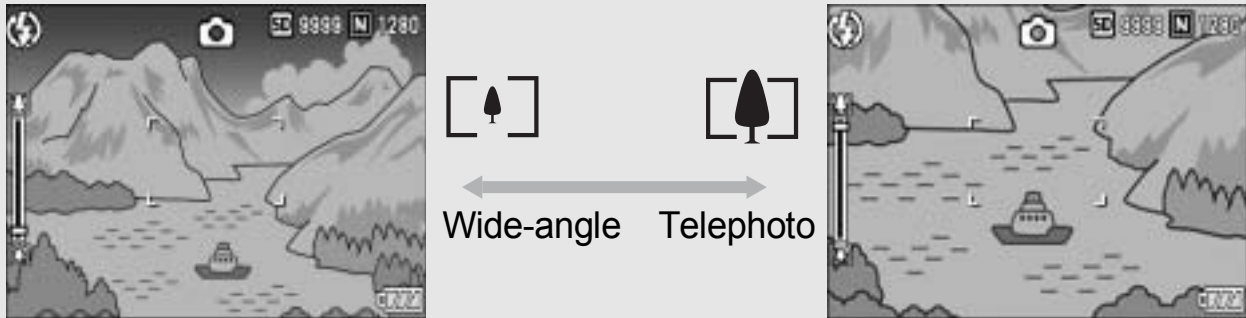

1 With the camera ready to shoot, turn the zoom lever toward [▼] (Telephoto) or [▲] (Wide-angle).

- You can check the zoom status on the zoom bar of the LCD monitor.

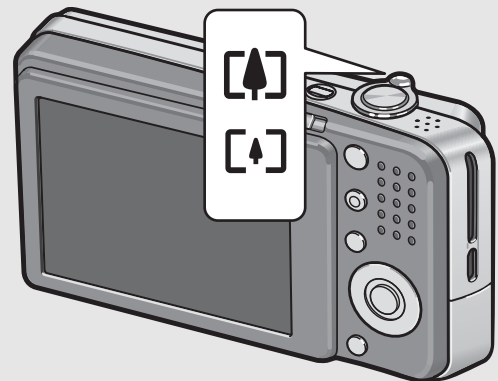

2 Compose your picture and half-press the shutter release button.

3 Full-press the shutter release button.



Using the Digital Zoom

Digital zooming enables you to enlarge the subject more than the maximum magnification of the optical zoom (7.1×) specified by turning the zoom lever toward [▼] (Telephoto) (up to 4.8×).

To use digital zooming, turn and hold the zoom lever toward [▼] (Telephoto) until the maximum magnification is reached on the zoom bar, then momentarily release the zoom lever, and then turn the zoom lever again toward [▼] (Telephoto).

You can also set [DIGITAL ZOOM IMG] to [AUTO RSZ]. (P.138)

If you are using the camera for the first time, read this section.



Shooting Close-Ups (Macro Shooting)

Using the  (Macro) button allows you to take a tight close-up of the subject. (Macro shooting)

This is good for shooting small subjects because you can shoot up to approximately 1 cm (0.4 in.) away.

If you are using the camera for the first time, read this section.

1 With the camera ready to shoot, press the  (Macro) button.

-  is displayed momentarily at the center of the LCD monitor and then  is displayed at the top of the screen.

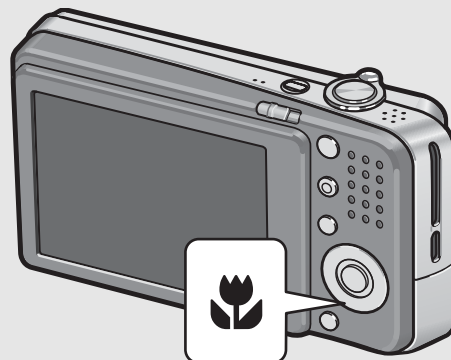

2 Compose your picture and half-press the shutter release button.

3 Full-press the shutter release button.

- To cancel macro mode, press the  (Macro) button again.



Note

- When using the zoom, you can shoot close-ups within the following distances:

Wide-Angle	About 1 cm	Shooting range: Approx. 25 mm × 19 mm (when digital zoom is not used)
		Shooting range: Approx. 5.2 mm × 4 mm (when 4.8× digital zoom is used)
Telephoto	About 25 cm	Shooting range: Approx. 61 mm × 46 mm (when digital zoom is not used)
		Shooting range: Approx. 12.7 mm × 9.6 mm (when 4.8× digital zoom is used)





- The AF target shift function enables you to lock the focus for macro shooting with the simple touch of a button without moving the camera. This function is useful for shooting on a tripod. (👉 P.62)
- To take a further close-up picture during macro shooting, use [ZOOM MACRO] in scene mode. (👉 P.39)

Using the Flash

Press the ⚡ (Flash) button to change the flash mode. At the time of purchase, the camera is set to [FLASH OFF].

From the front edge of the lens, the flash light reaches about 0.2 to 3.0 m (7.9 in. to 9.8 ft.) (Wide-angle) or about 0.25 to 2.0 m (9.8 in. to 6.6 ft.) (Telephoto) when the ISO setting is set to [AUTO].

Flash Modes

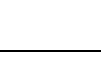
	FLASH OFF	The flash will not fire.
	AUTO	The flash fires automatically when the subject is poorly lit or backlit.
	RED-EYE FLASH	Reduces the red-eye phenomenon, in which people's eyes appear red in pictures.
	FLASH ON	The flash fires regardless of the lighting conditions.
	FLASH SYNCHRO.	The flash fires with the shutter speed slowed. This is useful when taking portrait pictures in a nightscape. Camera shake may occur, so the use of a tripod is recommended.
	SOFT FLASH	Reduces the amount of light fired by the flash. This is useful when using macro shooting to shoot close-ups.

1 Switch the mode selector to .

2 Press the ⚡ (Flash) button.

- The list of the flash modes mark is displayed on the LCD monitor.

3 Press the ▲▼ buttons to select the flash mode.

- The flash mode symbol is displayed at the upper left of the LCD monitor.
- The flash mode symbol blinks at the upper left of the LCD monitor when the flash is charging. Once the flash is charged, the symbol stops blinking and lights steadily and the camera is ready to shoot.



Note

- The flash mode setting is saved until you press the ⚡ (Flash) button again.
- The flash does not fire when shooting movies or in Multi-shot mode.
- The auxiliary flash fires to increase the AE accuracy.

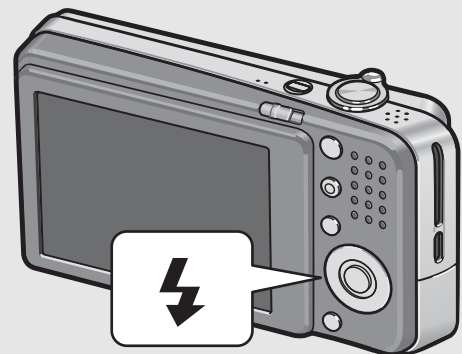

If you are using the camera for the first time, read this section.

Shooting with My Settings Mode

You can shoot using the settings (☞ P.127) registered in [REG. MY SETTINGS]. Select [MY SETTING 1] to shoot with settings registered in [SETTING 1] and select [MY SETTING 2] to shoot with settings registered in [SETTING 2].



If you are using the camera for the first time, read this section.

1 Switch the mode selector to MY.

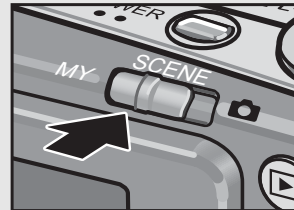
- The camera is ready to shoot,  is displayed at the top of the LCD monitor, and [MY SETTING 1] is selected.



2 Press the MODE button.

-  is displayed momentarily at the center of the LCD monitor, and then  is displayed at the top of the screen and [MY SETTING 2] is selected.
- Press  again to select [MY SETTING 1].

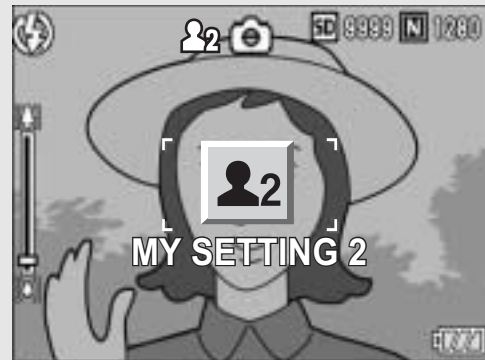









3 Press the shutter release button to shoot the picture.



Shooting with Optimal Settings According to Shooting Conditions

You can use scene mode to select from among eleven still image modes and movie, and shoot with settings automatically optimized for shooting conditions.

Scene Modes

 PORTRAIT	Use when taking portrait pictures.
 FACE	Automatically recognizes the subject's face and adjusts the focus, exposure, and white balance. For detailed operations, see P.41.
 SPORTS	Use when taking pictures of moving objects.
 LANDSCAPE	Use when taking scenery pictures with abundant greenery or blue sky.
 NIGHTSCAPE	Use when shooting night scenes. You can also shoot with persons in the frame. In Nightscape Mode, the flash fires when all of the following conditions are satisfied: <ul style="list-style-type: none"> • The flash is set to [AUTO]. • The flash is determined to be necessary because it is dark. • There is a figure or another object nearby.
 HIGH SENS	Use when taking pictures in dimly lit places. The LCD monitor also becomes brighter.
 ZOOM MACRO	Use when taking a further close-up picture during macro shooting. Using the digital zoom allows you to take a larger close-up than with normal macro shooting. For detailed operations, see P.43. The optical zoom cannot be used in this mode.
 B&W	Use when taking black and white still images.
 SEPIA	Use when taking sepia-toned still images.

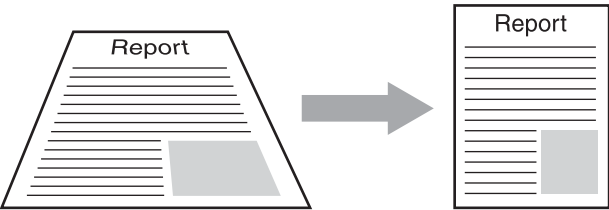
If you are using the camera for the first time, read this section.

 <p>SKEW COR MODE</p>	<p>Use to straighten a rectangular object, such as a message board or business card, shot at an angle to make it look as if it were shot squarely. For detailed operations, see P.42.</p> <div style="text-align: center;">  </div> <p>In skew correction mode, choose from [F1280], [N1280], and [N640] for [PIC QUALITY/SIZE]. (P.66)</p>
 <p>TEXT MODE</p>	<p>Use when capturing text images, for example notes written on a whiteboard at a meeting. Images are captured in black and white. You can also change the shading of text. (P.61)</p> <p>You can set the image size to either 3072 × 2304 or 2048 × 1536 pixels. (P.66)</p>
 <p>MOVIE</p>	<p>Allows you to shoot movies with sound.</p>



Note

For information on shooting setting menu items and function restrictions in scene mode, see “Appendices”. (P.182)

1

Switch the mode selector to SCENE.

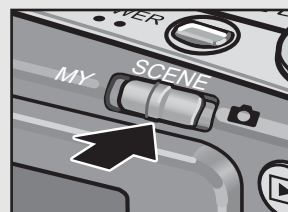

- The camera is ready to shoot and the selected scene mode is displayed at the top of the LCD monitor.



2

Press the MODE button to change the scene mode.

- The scene mode selection screen appears.

3 Press the ▲▼◀▶ buttons to select the scene mode.

- Press the DISP. button to change the display of the scene mode selection screen. Each time you press the DISP. button, the display switches between the list display screen and the detailed display screen. You can use either screen to select the scene mode.



List display screen



Detailed display screen

4 Press the MENU/OK button.

- The scene mode type is displayed at the top of the LCD monitor.

5 Press the shutter release button to shoot the picture.

Returning to Normal Shooting Mode

1 Switch the mode selector to .

Using Face Recognition Mode

1 Switch the mode selector to **SCENE**.

- The camera is ready to shoot and the selected scene mode is displayed at the top of the LCD monitor.

2 Press the **MODE** button.

- The scene mode selection screen appears.

3 Press the ▲▼◀▶ buttons to select [**FACE**].

4 Press the **MENU/OK** button.

If you are using the camera for the first time, read this section.

5 Compose your picture.

- When a face is recognized, a frame the size of the recognized face is displayed in blue.
- Up to four frames can be displayed.

6 Half-press the shutter release button.

- Even if several faces are recognized, the camera selects the optimal focus. When a recognized face is focused, the frame for that face is displayed in green. If the camera cannot focus on a recognized face, the frame for that face disappears.
- The exposure and white balance are locked.

7 Gently press the shutter release button all the way.

Using the Skew Correction Mode

1 Switch the mode selector to SCENE.

- The camera is ready to shoot and the selected scene mode is displayed at the top of the LCD monitor.

2 Press the MODE button.

- The scene mode selection screen appears.

3 Press the ▲▼◀▶ buttons to select [SKEW COR MODE].

4 Press the MENU/OK button.

5 Press the shutter release button to shoot the picture.

- The display indicates that the image is being processed, and then the area recognized as the correction range is displayed with an orange frame. Up to five areas can be recognized.
- If the target area cannot be detected, an error message appears. The image before correction remains recorded.
- To select another correction area, move the orange frame to the target area by pressing the ► button.
- To cancel skew correction, press the ▲ button. Even if you cancel skew correction, the image before skew correction remains recorded.

6 Press the MENU/OK button.

- The display indicates that the image is being corrected, and then the corrected image is recorded. The image before correction is also recorded.



Caution-----

When [SKEW COR MODE] is selected, note the following:

- To shoot the subject as large as possible, position it so that the entire portion of the subject is visible on the LCD monitor.
- The camera may fail to recognize the subject in the following cases:
 - When the image is out of focus
 - When four edges of the subject are not clearly visible
 - When it is hard to distinguish between the subject and background
 - When the background is complicated
- Two images, one before correction and the other after correction, are recorded. If the number of remaining shots is less than two, you cannot shoot the subject.



Note-----

You can also correct the skew of a previously shot still image. (👉 P.110)

Shooting in Zoom Macro Mode

1 Switch the mode selector to **SCENE**.

- The camera is ready to shoot and the selected scene mode is displayed at the top of the LCD monitor.

2 Press the **MODE** button.

- The scene mode selection screen appears.

3 Press the **▲▼◀▶** buttons to select **[ZOOM MACRO]**.

4 Press the **MENU/OK** button.

5 Turn the zoom lever toward **[👆]** (Telephoto) or **[👇]** (Wide-angle).

- The zoom level appears on the LCD monitor.

6 Compose your picture and half-press the shutter release button.

7 Full-press the shutter release button.



Caution-----

- When using the zoom macro, you can shoot close-ups within the following distances:

About 1cm	Shooting range: Approx. 21.6 mm × 16.2 mm (when digital zoom is not used)
	Shooting range: Approx. 4.5 mm × 3.4 mm (when 4.8× digital zoom is used)

- When [DIGITAL ZOOM IMG] is set to [AUTO RSZ], the auto resize zoom is activated. (👉 P.138)

Using the Self-Timer

You can set the Self-timer to shoot after either two or ten seconds. A setting of two seconds is useful for preventing camera shake.

1 Switch the mode selector to .

2 Press the  (Self-timer) button.

- The Self-timer symbol appears on the screen.
- The [10] to the right of the symbol indicates the number of seconds. In this case, if you press the shutter release button, the camera shoots after 10 seconds.
- Each press of the  (Self-timer) button changes the self-timer setting in the following order: 10 sec, 2 sec, and Self-timer Off.



3 Press the shutter release button.

- The focus is locked, and the AF auxiliary light/self-timer lamp lights for 8 seconds when the self-timer starts and then blinks for the final 2 seconds.



Note

- The camera remains in self-timer mode even after the image is shot. To cancel the self-timer, press the  (Self-timer) button and change the self-timer setting to [SELF-TIMER OFF].
- When the AF auxiliary light/self-timer is set to 2 seconds, the self-timer lamp does not light or blink.

If you are using the camera for the first time, read this section.

Playing Back Images







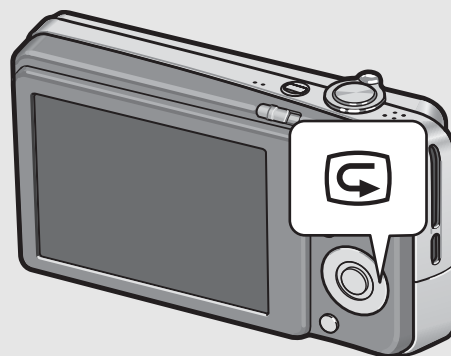

Reviewing the Image You Just Took (Quick Review)

You can view the image you just took on the LCD monitor. If you are not pleased with the way the photo came out, you can delete it then and there.

1 In shooting mode, press the (Quick Review) button.



- The last image you took is displayed on the LCD monitor.



In Quick Review	
 Button	Returns to shooting mode.
 on the Zoom Lever	Enlarges the displayed still image. You can move the displayed still image by pressing the     buttons.
 on the Zoom Lever	Reduces the enlarged still image.
MENU/OK Button	Enlarges the enlarged still image at maximum magnification. Pressing this again returns the still image to its original size.
 Button	Deletes the currently displayed file. When the  button is pressed, a warning message about deleting the file appears. Select [DELETE] and press the MENU/OK button.
DISP. Button	Displays the white saturation highlights display screen. Press the DISP. button again to display the quick review screen.



Note





- Once the power is turned off, the image you took cannot be displayed in shooting mode even if you press the  (Quick Review) button.
- If you use Quick Review to view the image taken in [TEXT MODE] of scene mode ( P.40), the displayed image may have a slightly lower quality than the recorded one.

If you are using the camera for the first time, read this section.

Viewing Your Images

In playback mode, you can check still images you have taken. You can also delete or zoom in on the images.

1 Press the (Playback) button.

- The camera switches to playback mode and the last still image you took is displayed.
- You can view your pictures in order by using the   buttons.
- Press the  button to display the still image 10 frames backward. If there are less than 10 still images, the first still image is displayed.
- Press the  button to display the still image 10 frames forward. If there are less than 10 still images, the last still image is displayed.
- To switch the camera from playback mode to shooting mode, press the  (Playback) button again.

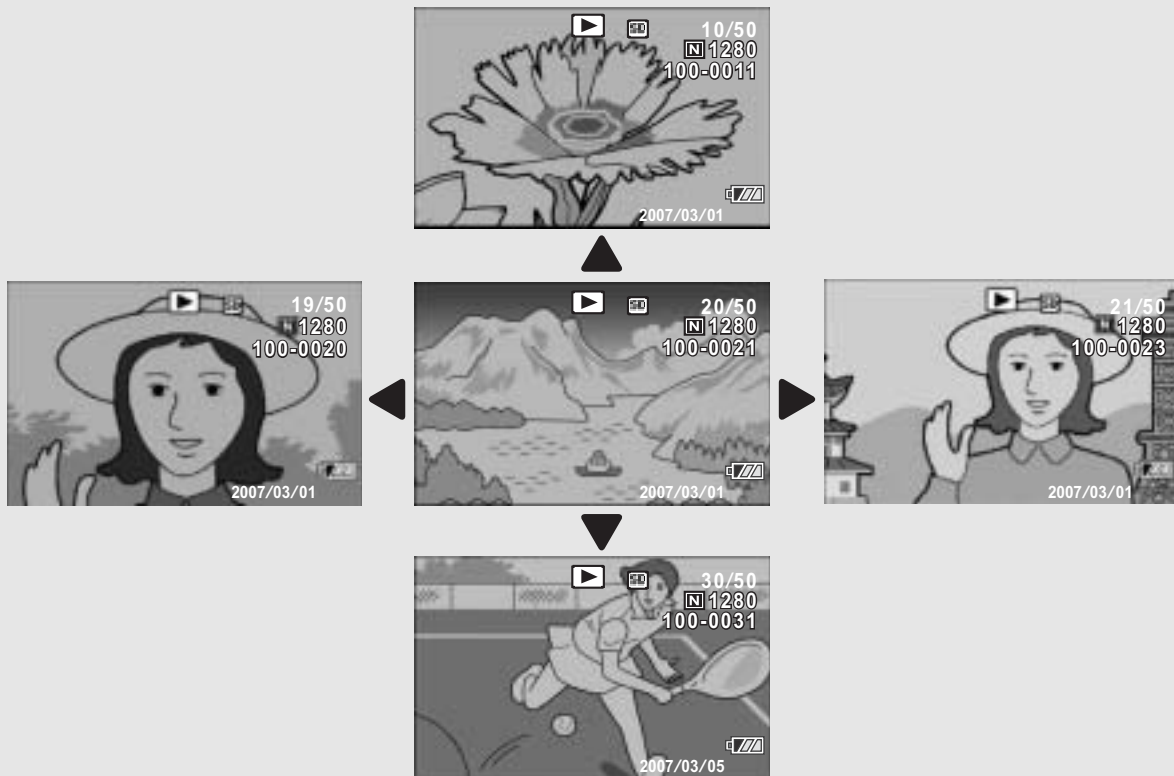
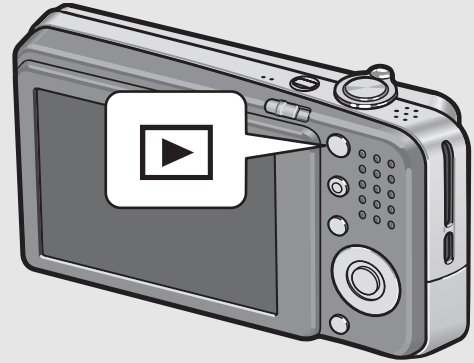



If you are using the camera for the first time, read this section.



Turning on the camera in playback mode-----

When the camera is off, pressing the  (Playback) button for more than one second turns the camera on. (The camera starts up in playback mode.)

When the camera has been turned on with the  (Playback) button, pressing the  (Playback) button again switches playback mode to shooting mode.

Where images are played back from-----

When no SD memory card is loaded, the camera plays back from the internal memory.

When an SD memory card is loaded, it plays back from the SD memory card.

If you are using the camera for the first time, read this section.

Three-frame View/Grid View (Thumbnail Display)

When playing back images on the LCD monitor, the playback screen can be divided into three frames (three-frame view) or 12 frames (grid view). The three-frame view and grid view allow you to select a still image to enlarge or delete.

The playback screen changes as follows:



1 Press the (Playback) button.

- The last image you took is displayed.

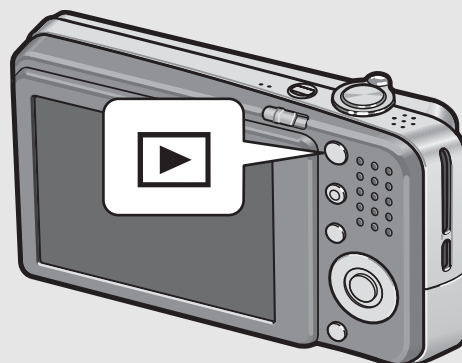

2 Turn the zoom lever toward (Thumbnail Display).

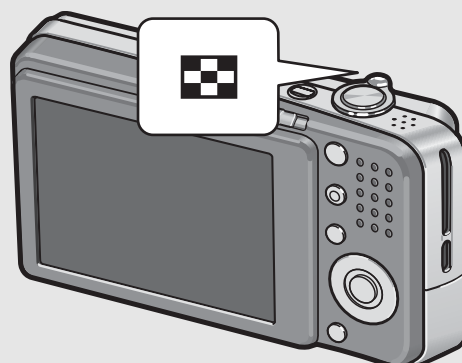

If you are using the camera for the first time, read this section.

- The screen changes to three-frame view. The large frame at the center of the screen displays the currently selected still image.
- Press the ▲ button to display the still image 10 frames backward. If there are less than 10 still images, the first still image is displayed.
- Press the ▼ button to display the still image 10 frames forward. If there are less than 10 still images, the last still image is displayed.

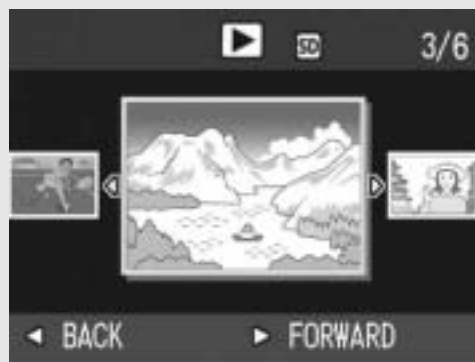

3 Turn the zoom lever toward (Thumbnail Display) again during three-frame view.

- The screen is divided into 12 frames.

Selected still image

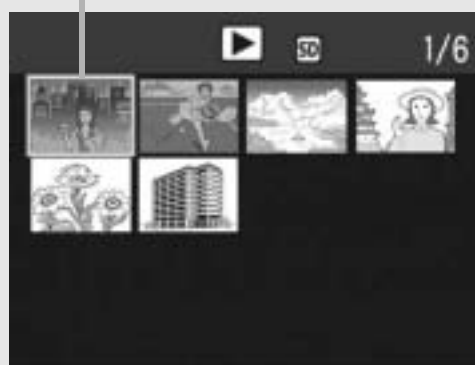

Switching to Single-Picture Display

● In Three-Frame View

- 1 Press the ◀▶ buttons to select a still image.**
- 2 Turn the zoom lever toward  (Enlarged View) or press the MENU/OK button.**



● In Grid View

- 1 Press the ▲▼◀▶ buttons to select a still image.**
- 2 Turn the zoom lever toward  (Enlarged View) twice.**



Note -----

If any of the following operations is performed in the three-frame view, the display returns to the ordinary playback screen (single-picture display) and the operation is executed.

- Deletion ( P.51)
- Menu display ( P.100)
- Movie playback ( P.99)

Magnifying Images

You can enlarge a still image displayed on the LCD monitor.

Image Size	Enlarged View (maximum magnification)
3072 × 2304, 3072 × 2048, 2592 × 1944, 2048 × 1536	16 times
1280 × 960	6.7 times
640 × 480	3.4 times

1 Press the  (Playback) button.





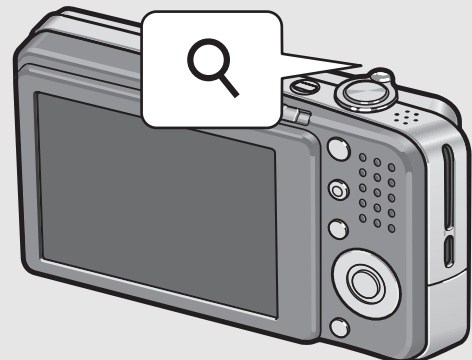

- The last image you took is displayed.

2 Press the     buttons to display the still image you want to enlarge.

3 Turn the zoom lever toward  (Enlarged View).

- The still image is enlarged.



In Enlarged View	
 on the Zoom Lever	Enlarges the displayed still image. You can move the displayed still image by pressing the     buttons.
 on the Zoom Lever	Returns the enlarged still image to its original size.
MENU/OK Button	Pressing this in enlarged view displays the still image at the maximum magnification. Pressing this again returns the still image to its original size.



Note

- Enlarged view is also available in the quick review mode.
- Movies cannot be enlarged.

If you are using the camera for the first time, read this section.

Deleting Files

You can delete unwanted or failed files from the SD memory card or internal memory.

You can use the [RECOVER FILE] function to restore files that you accidentally deleted. (👉 P.112)

Deleting a File

- 1** Press the  (Playback) button.
- 2** Press the  buttons to display the file you want to delete.
- 3** Press the  (Delete) button.
- 4** Press the  buttons to select [DELETE ONE].
 - You can change the image for deletion with the  buttons.
- 5** Press the MENU/OK button.
 - The display indicates that the files are being deleted; once finished, it returns to the screen in Step 4.

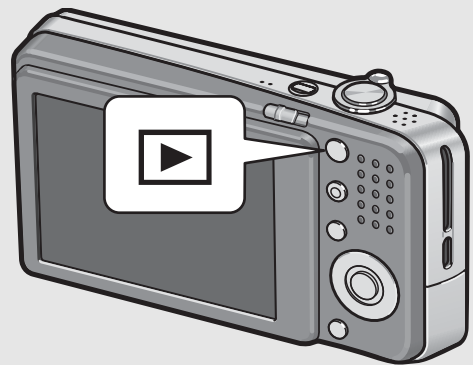

If you are using the camera for the first time, read this section.

Deleting All Files

- 1** Press the  (Playback) button.
- 2** Press the  (Delete) button.
- 3** Press the  buttons to select [DELETE ALL].
- 4** Press the MENU/OK button.
 - You are prompted to confirm that you want to delete all images. If so, press the  button to select [YES], and then press the MENU/OK button.

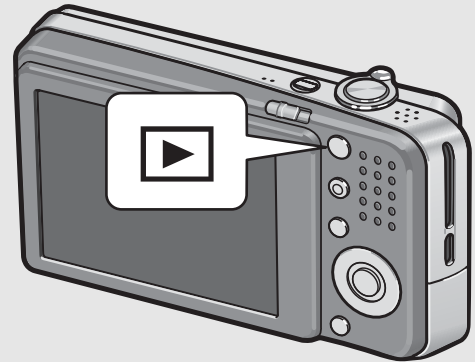

Note

You can also delete files by pressing the  (Delete) button during three-frame view ( P.48).

Deleting Multiple Files at One Time

You can delete multiple files at a time by specifying the files individually, by specifying a range of files to be deleted, or by combining these two methods.

- 1** Press the  (Playback) button.
- 2** Turn the zoom lever toward  (Thumbnail Display) twice.
 - The screen is divided into 12 frames.
- 3** Press the  (Delete) button.

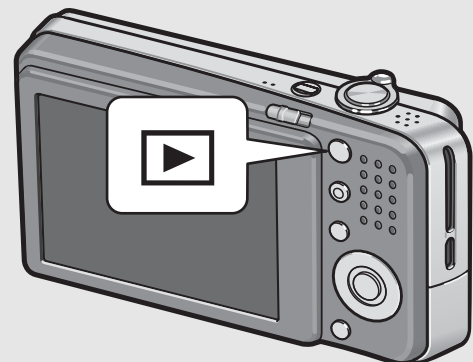

● Specifying Individual Files to be Deleted

4 Press the ▲▼◀▶ buttons to select the file you want to delete and press the  (Delete) button.

- The trash symbol is displayed in the upper left corner of the file.

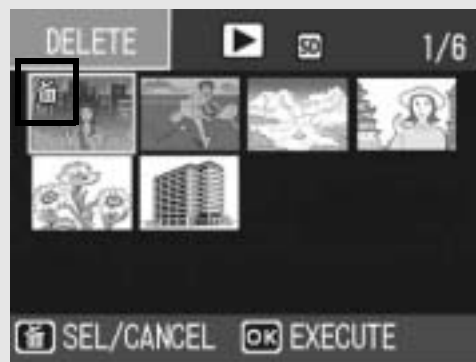

5 Repeat Step 4 to select all the files you want to delete.

- If you selected a file by mistake, you can deselect it by selecting the file and pressing the  (Delete) button.

6 Press the MENU/OK button.

7 Press the ◀▶ buttons to select [YES] and then press the MENU/OK button.

- The display indicates that the files are being deleted; once finished, it returns to the thumbnail display screen.

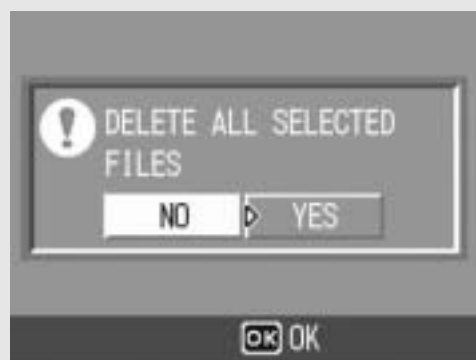

If you are using the camera for the first time, read this section.

● Specifying a Range of Files to be Deleted

4 Press ADJ.button.

- Press the ADJ. button again to return to the screen for deleting one file at a time.

5 Press the ▲▼◀▶ buttons to select the starting point of the range of files you want to delete and press the  (Delete) button.

- The trash symbol is displayed in the upper left corner of the file.

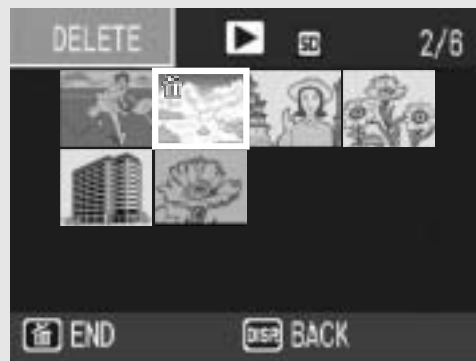

6 Press the ▲▼◀▶ buttons to select the ending point of the range of files you want to delete and press the  (Delete) button.

- The trash symbol is displayed in the upper left corner of the specified files.

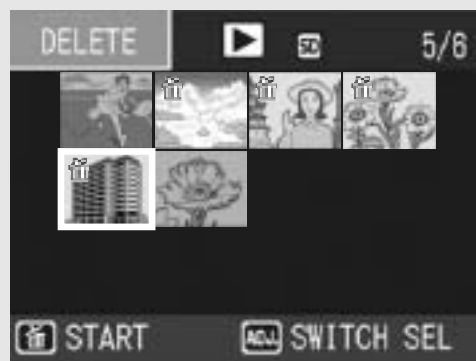

7 Repeat Steps 5 and 6 to specify all the ranges of files you want to delete.

- If you selected a file by mistake, you can deselect it by pressing the ADJ. button to return to the screen for deleting one file at a time, selecting the file, and pressing the  (Delete) button.

8 Press the MENU/OK button.

9 Press the ◀▶ buttons to select [YES] and then press the MENU/OK button.

- The display indicates that the files are being deleted; once finished, it returns to the thumbnail display screen.

Changing the Display with the DISP. Button

Pressing the DISP. button allows you to change the screen display mode and toggle the information displayed on the LCD monitor.

● During Shooting Mode

Each time you press the DISP. button, the display changes in the following order: Histogram, Grid Guide, No Display, LCD Monitor Off, and Normal Symbol Display.

Normal Symbol Display



Histogram



Grid Guide

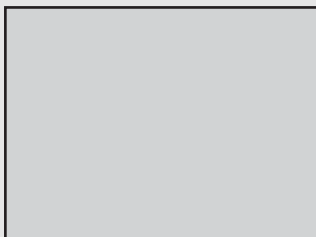
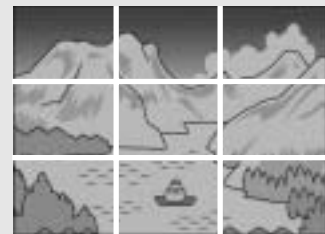

LCD Monitor Off
(Synchro-Monitor Mode)

Press the DISP. button to
change the display.



No Display



Grid Guide -----

This displays auxiliary lines on the LCD monitor to help you compose your picture. These lines are not recorded with images.

Synchro-Monitor Mode -----

This turns the LCD monitor off except when the camera is operated. This mode is effective for saving power consumption. In this mode, pressing the shutter release button halfway turns the LCD monitor on. Subsequently, pressing the shutter release button fully displays the shot image on the LCD monitor and then turns the LCD monitor off.



Note -----

When [ENLGE PHOTO ICON] is turned on (P.141), the following are not displayed in normal symbol display.

Zoom bar/Focus bar, Date imprint, Sharpness, Color depth

If you are using the camera for the first time, read this section.

● **During Quick Review**

Pressing the DISP. button switches to the white saturation highlights display. On the white saturation highlights display, the white saturation areas of the image flash in black. Pressing the DISP. button again returns to the Quick Review screen.

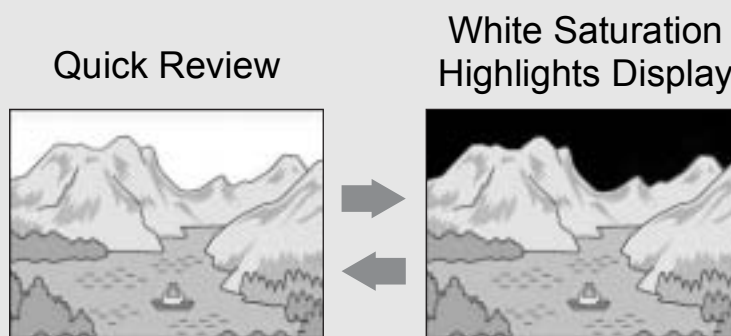

Press the DISP. button to change the display.

● **During Playback Mode**

Each time you press the DISP. button, the display changes in the following order: Histogram, White Saturation Highlights Display, No Display, and Normal Symbol Display.

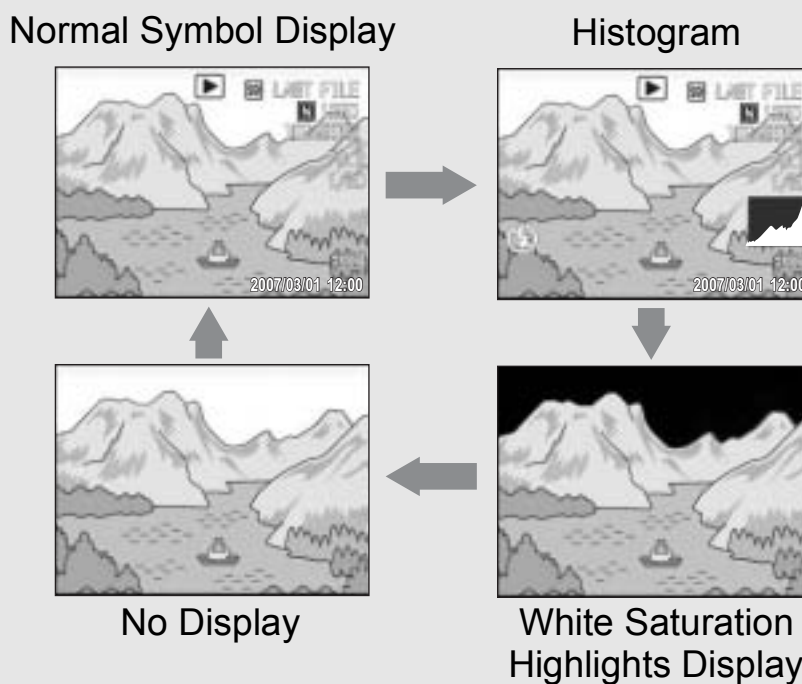

Press the DISP. button to change the display.



White Saturation Highlights Display -----

The white saturation areas of the image flash in black. White saturation is the loss of grayscale that indicates the color shading in an image in which very bright areas of the subject are rendered in white. An image with a loss of grayscale cannot be edited later. It is recommended that you shoot another image while avoiding direct sunlight and setting the exposure level lower (-) (☞ P.86).



Note -----

The white saturation highlights display is for reference only.

Maximizing the LCD Monitor Brightness

Hold the DISP. button down to maximize the display brightness. When the brightness is at the maximum setting, holding the DISP. button down returns the brightness to the level set in [LCD BRIGHTNESS] (☞ P.126).

Histogram

When Histogram is on, a histogram appears in the lower right corner on the LCD monitor. A histogram is a graph indicating the number of pixels on the vertical axis and the brightness on the horizontal axis (from left to right, shadows (dark areas), midtones, and highlights (bright areas)).



By using the histogram, you can determine the brightness of an image without being affected by the brightness around the LCD monitor. This also helps you correct for areas that are overly bright or dark.

If the histogram has only peaks on the right side without anything else, this picture is over-exposed with too many pixels only for highlight sections.



If the histogram has only peaks on the left side without anything else, this picture is under-exposed with too many pixels only for shadow sections. Correct the exposure to an appropriate level.



If you are using the camera for the first time, read this section.



Note -----

- The histogram displayed on the LCD monitor is for reference only. Depending on the shooting conditions (use of the flash, dark surrounding light, etc.), the exposure level indicated in the histogram may not correspond to the brightness of the shot image.
- Exposure compensation has its limitation. It does not necessarily achieve the best possible result.
- A histogram with peaks in the center may not necessarily provide the best result to suit your particular requirements.
For example, an adjustment is required if you want to underexpose or overexpose the image.
- For information on how to correct the exposure compensation, see P.86

Advanced Operations

Read this section when you want to learn more about the different camera functions.

1	Various Shooting Functions	60
2	Shooting/Playing Back Movies	96
3	Other Playback Functions	100
4	Direct Printing	115
5	Changing Camera Settings	121
6	Downloading Images to Your Computer	149
7	Appendices	168

1

2

3

4

5

6

7

1 Various Shooting Functions

Using the ADJ. Button

You can use the ADJ. button to set various shooting settings with fewer operations. In ADJ. mode, you can register four functions. Use the SETUP menu to assign functions to the ADJ. button. (P.136) By assigning a frequently used function to the ADJ. button, you can more easily set that function with fewer button operations.

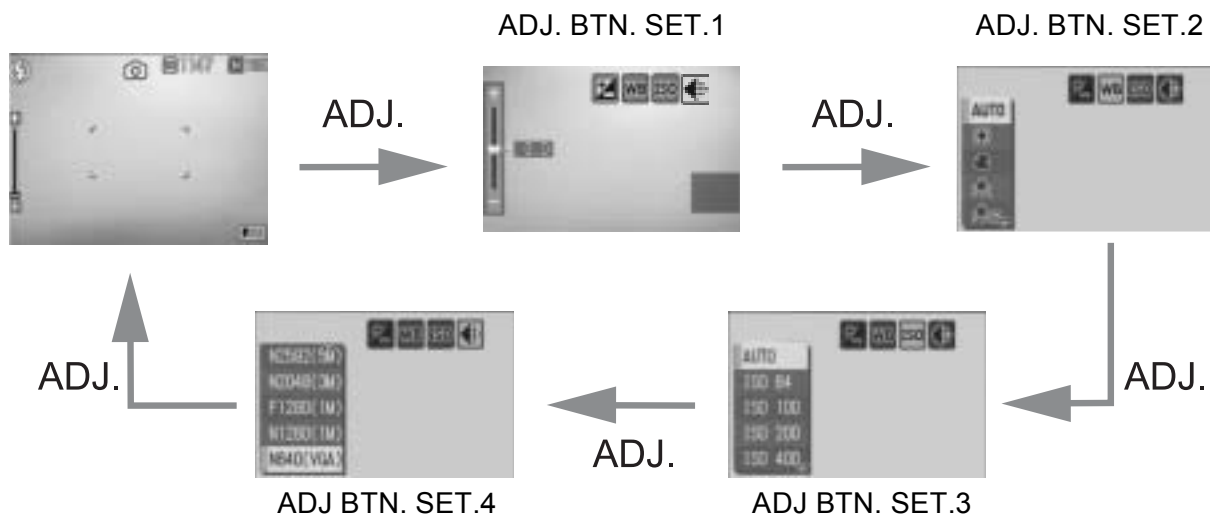

The screenshots above are examples of the screen display when [EXPOSURE COMP.], [WHITE BALANCE], [ISO], and [QUALITY] are assigned to [ADJ. BTN. SET.1] to [ADJ. BTN. SET.4]. Press the ▲▼ buttons to select the desired value, and then press the MENU/OK button to confirm the setting.

Settings by Mode

The settings that can be made with the ADJ. button differ among scene mode and auto shooting mode. The following settings can be made with the ADJ. button.

Mode	Available Settings
Auto Shooting Mode	Functions assigned to the ADJ. button
Scene Mode ([MOVIE])	White balance
Scene Mode ([TEXT MODE])	Text density
Scene Mode (other than [TEXT MODE])	Exposure compensation, white balance

Functions That Can Be Assigned to the ADJ. Button

EXPOSURE COMP., WHITE BALANCE, ISO, QUALITY, FOCUS, SHARPNESS, AE METERING, CONT. MODE, AUTO BRACKET, WITH SND

Changing the Text Density (Scene Mode)

You can change the shading of text for shooting with [TEXT MODE] (👉 P.40) in scene mode.

You can select from [DEEP], [NORMAL] and [LIGHT].

To change the setting, use the shooting setting menu or the ADJ. button. This section explains easy ways to change the shading setting with the ADJ. button.

To use the shooting setting menu, see “Using the Menu” (👉 P.65) and “Shooting Setting Menu Items by Scene Mode” (👉 P.183).

1 Switch the mode selector to **SCENE**.

2 Press the **MODE** button.

- The scene mode selection screen appears.

3 Press the ▲▼◀▶ buttons to select [TEXT MODE] and then press the MENU/OK button.



4 Press the **ADJ.** button.

- The text density menu appears.

5 Press the ▲▼ buttons to select the desired density setting.

- You can also press the shutter release button to take the picture.

6 Press the **MENU/OK** button.

- The text density setting does not appear on the screen.



Shifting the AF Target (Macro)

During macro shooting, pressing the ADJ. button allows you to shift the AF target (👉 P.32) by using the ▲▼◀▶ buttons on the camera without moving the camera. This is useful for macro shooting on a tripod.



When the AF target is shifted to the left with the ◀ button



1 With the camera ready to shoot, press the 🌸 (Macro) button.

- The macro symbol appears on the screen.

2 Press the ADJ. button.

3 Press the ◀▶ buttons until the AF target shift function screen (cross-mark in the middle of the screen) appears.

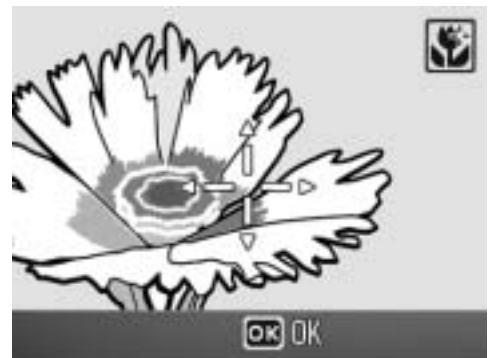

4 Shift the cross-mark to the subject you want the camera to focus on with the ▲▼◀▶ buttons.

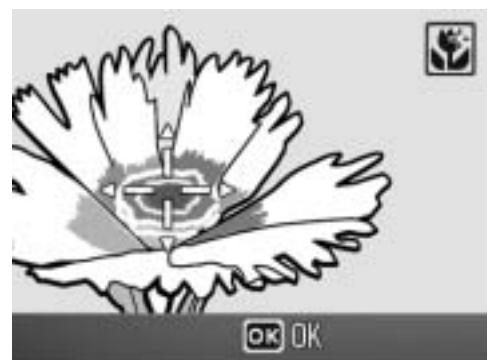

5 Press the MENU/OK button.

6 Half-press the shutter release button.

- The camera focuses on the area at the position of the cross-mark.

7 Gently press the shutter release button all the way.





- The AF target shift function automatically focuses the camera on the set position until macro mode is cancelled.

Shooting Setting Menu







Press the MENU/OK button in shooting mode to display the shooting setting menu. The shooting setting menu can be used to set the following shooting settings.

When Mode Selector is Set to /SCENE/MY

- When mode selector is set to SCENE, the settings that can be selected are restricted. (👉 P.64, 183)

Setting	Options [Default Settings]	Refer to
PIC QUALITY/SIZE	F3072(7M), [N3072(7M)], F3:2(7M), F2592(5M), N2592(5M), F2048(3M), N2048(3M), F1280(1M), N1280(1M), N640(VGA)	P.66
FOCUS	[MULTI AF], SPOT AF, MF, SNAP, ∞	P.68
AE METERING	[MULTI], CENTER, SPOT	P.71
SHARPNESS	SHARP, [NORMAL], SOFT	P.72
CONT. MODE	[OFF], CONT., S-CONT, M-CONT	P.73
COLOR DEPTH	[NORMAL], VIVID, NEUTRAL	P.77
AUTO BRACKET	[OFF], ON, WB-BKT	P.78
TIME EXPOSURE	[OFF], 1 SEC., 2 SEC., 4 SEC., 8 SEC.	P.81
INTERVAL	[0 s], 5 seconds to 3 hours	P.82
IMAGE WITH SOUND	[OFF], ON	P.84
DATE IMPRINT	[OFF], DATE, TIME	P.85
EXPOSURE COMP.	-2.0 to +2.0	P.86
WHITE BALANCE	[AUTO],  (OUTDOORS),  (CLOUDY),  (INCANDESCENT LAMP),  (INCANDESCENT LAMP2),  (FLUORESCENT LAMP), [M] (MANUAL SETTINGS)	P.87
ISO SETTING	[AUTO], AUTO-HI, ISO 64, ISO 100, ISO 200, ISO 400, ISO 800, ISO 1600	P.90
SLOW SHUTTER LMT	OFF, 1/2SEC., 1/4SEC., [1/8SEC.]	P.92
CAMERA SHAKE COR	OFF, [ON]	P.93
RECORD DUAL SIZE	[OFF], ON	P.94
RESTORE DEFAULTS	_____	P.95

When Scene Mode Selector is Set to

Setting	Options [Default Settings]	Refer to
MOVIE SIZE	640, [320], 160	P.66
FRAME RATE	[30FPS], 15FPS	P.97
FOCUS	[MULTI AF], SPOT AF, MF, SNAP, ∞	P.68
WHITE BALANCE	[AUTO],  (OUTDOORS),  (CLOUDY),  (INCANDESCENT LAMP),  (INCANDESCENT LAMP2),  (FLUORESCENT LAMP),  (MANUAL SETTINGS)	P.87

1

Various Shooting Functions



Note

 The SETUP menu can be accessed from within the shooting setting menu. ( P.121)

Using the Menu

This explains how to make the settings.

Use the ▲▼▶ buttons and MENU/OK button to select and set an item.

1 Press the MENU/OK button in shooting mode.

- The shooting setting menu is displayed.

The menu items are provided on four screens.

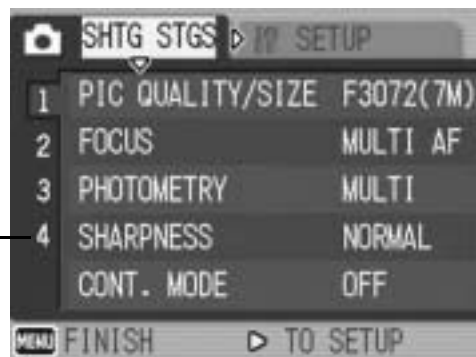

2 Press the ▲▼ buttons to select the desired menu item.

- Press the ▼ button at the bottom item to display the next screen.

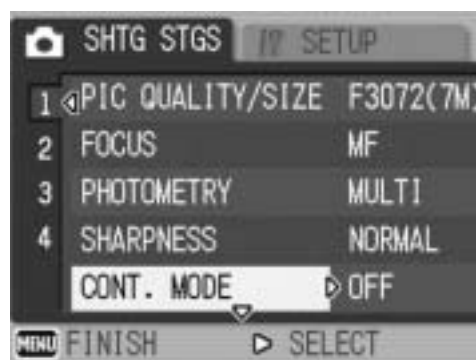

3 Press the ▶ button.

- The menu item settings are displayed.

4 Press the ▲▼ buttons to select the setting.

5 Press the MENU/OK button, or ◀ button and press the MENU/OK button.

- The setting is set.
- The shooting setting menu disappears and the camera is ready to shoot.



Changing the display -----

- You can select a screen by the screen number:
 - 1 Press the ◀ button to select a screen number on the left of the screen.
 - 2 Press the ▲▼ buttons to change screens.
 - 3 Press the ▶ button to return to menu item selection.



Choosing Picture Quality Mode/ Image Size (PIC QUALITY/SIZE)

The file size of a shot still image depends on the picture quality mode and image size settings. For movies, choose the movie size. Figures inside the bold frame indicate those shown on the screen.

Still Images

Image Size	Picture Quality Mode	PIC QUALITY/ SIZE	Remarks
3072 × 2304	F (Fine) N (Normal)	F3072(7M) N3072(7M)	<ul style="list-style-type: none"> • For downloading and editing images on your computer.
3072 × 2048	F (Fine)	F3:2(7M)	<ul style="list-style-type: none"> • For creating large prints.
2592 × 1944	F (Fine) N (Normal)	F2592(5M) N2592(5M)	<ul style="list-style-type: none"> • For creating prints.
2048 × 1536	F (Fine) N (Normal)	F2048(3M) N2048(3M)	
1280 × 960	F (Fine) N (Normal)	F1280(1M) N1280(1M)	<ul style="list-style-type: none"> • For shooting a large number of pictures.
640 × 480	N (Normal)	N640(VGA)	<ul style="list-style-type: none"> • For shooting a large number of pictures. • For attaching to e-mail. • For posting on a website.

- When scene mode is set to [SKEW COR MODE], you can select 1280 × 960 or 640 × 480.
- When scene mode is set to [TEXT MODE], you can select 3072 × 2304 or 2048 × 1536.
- When the image size is set to [F3:2], a black border is added to the top and bottom of the image on the LCD monitor in accordance with the shooting range.

Movies

Image Size	Movie Size
640 × 480	640
320 × 240	320
160 × 120	160

- You can also choose the number of frames for movies. (👉 P.97)



Note -----

- For picture quality mode, select normal mode (N) or fine mode (F), depending on the desired compression ratio.
 Normal mode: The compression ratio is high, resulting in a small file. Normally, shooting is done in this mode.
 Fine mode: The compression ratio is low, resulting in a large file, but the picture quality is better than in Normal.
- The number of images that can be stored in the internal memory or SD memory card depends on the [PIC QUALITY/SIZE] setting. (☞ P.178)

1 Switch the mode selector to .

2 Press the MENU/OK button.

- The shooting setting menu is displayed.

3 Press the ▼ button to select [PIC QUALITY/SIZE] and press the ► button.

4 Press the ▲▼ buttons to select the desired setting.

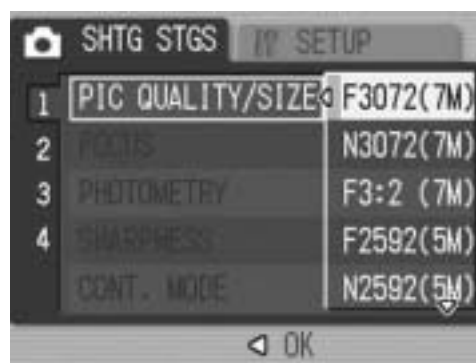

Still Images



Movies

5 Press the MENU/OK button, or ◀ button and press the MENU/OK button.



- The setting appears on the screen.

Changing the Focusing Mode (FOCUS)

If you shoot the subject in the default focusing mode, the camera focuses automatically with Auto Focus (AF).

Select from the following five focusing modes.

Focusing Modes

Symbol	Mode	Description
None	MULTI AF	Automatically measures the distances to a maximum of five AF areas from among 17 AF areas and focuses to the nearest AF area. This prevents the center of the LCD monitor from becoming out of focus and enables you to shoot with a minimum number of out-of-focus pictures.
None	SPOT AF	Selects one AF area at the center of the picture to allow the camera to focus on this area automatically.
	MF (Manual Focus)	Enables you to adjust the focus manually.
	SNAP	Fixes the shooting distance to a short distance (about 2.5 m (8.2 ft.)).
	∞ (Infinity)	Fixes the shooting distance to infinity. Infinity is useful for shooting distant scenes.

- 1 Switch the mode selector to .
- 2 Press the MENU/OK button.
 - The shooting setting menu is displayed.
- 3 Press the ▼ button to select [FOCUS] and press the ► button.
- 4 Press the ▲▼ buttons to select the desired setting.
- 5 Press the MENU/OK button, or ◀ button and press the MENU/OK button.



Manual Focus Shooting (MF)

If the camera fails to focus automatically, you can focus manually (MF: Manual Focus).

Manual focus enables shooting at a fixed distance.



Note

- In scene mode, manual focus can be used when [ZOOM MACRO], [B&W], [SEPIA], [SKEW COR MODE], or [MOVIE] is selected.
- You can also use manual focus to focus on objects within the macro shooting range.

1 Switch the mode selector to .

2 Press the MENU/OK button.

- The shooting setting menu is displayed.

3 Press the ▼ button to select [FOCUS] and press the ► button.

4 Press the ▲▼ buttons to select [MF].



5 Press the MENU/OK button.

- [MF] is displayed on the screen.



6 Press the ▼ button as required.

- Pressing the ▼ button enlarges the display for easy focusing.

7 Press the **▶** button to display the focus bar.

- Each time the **▶** button is pressed, the focus bar and zoom bar appear alternately.



8 Turn the zoom lever toward **[▲]** (Telephoto) or **[▼]** (Wide-angle) to adjust the focus.

- Turning the zoom lever toward **[▲]** (Telephoto) adjusts the focus to farther objects.
Turning the zoom lever toward **[▼]** (Wide-angle) adjusts the focus to closer objects.

9 Press the shutter release button to shoot the picture.



Note



When the zoom bar is displayed, you can operate the zoom bar by turning the zoom lever toward **[▲]** (Telephoto) or **[▼]** (Wide-angle).

Changing the Light Metering (AE METERING)

You can change the metering method (the range to use for metering) used to determine the exposure value.

There are three light metering modes.

Light Metering Modes

Symbol	Mode	Description
None	MULTI	The entire shooting range is divided into 256 partitions, and each is metered to determine the overall exposure value.
	CENTER	The entire image is metered, with emphasis on the center, to determine the exposure value. Use this when the brightness of the center and surroundings are different.
	SPOT	Only the center of the image is metered to determine the exposure value. Use this setting when you want to use the brightness at the center. This is useful if there is a marked difference in contrast or backlighting.

1 Switch the mode selector to .

2 Press the MENU/OK button.

- The shooting setting menu is displayed.

3 Press the ▼ button to select [AE METERING] and press the ► button.

4 Press the ▲▼ buttons to select the desired setting.



5 Press the MENU/OK button, or ◀ button and press the MENU/OK button.

- The symbol appears on the screen.



Changing the Edge Quality of Still Images (SHARPNESS)

You can change the edge quality of your still images to either sharp or soft.

1 Switch the mode selector to .

2 Press the MENU/OK button.

- The shooting setting menu is displayed.

3 Press the ▼ button to select [SHARPNESS] and press the ► button.

4 Press the ▲▼ buttons to select the desired setting.



5 Press the MENU/OK button, or ◀ button and press the MENU/OK button.

- The symbol appears on the screen.



Shooting with Multi-Shot (CONT./S-CONT/M-CONT)

With Multi-shot, you can shoot consecutive images. Multi-shot has the following three modes:

CONT.

Pictures continue to be taken for as long as you hold down the shutter release button.

Still images are recorded one at a time, just as in normal shooting.

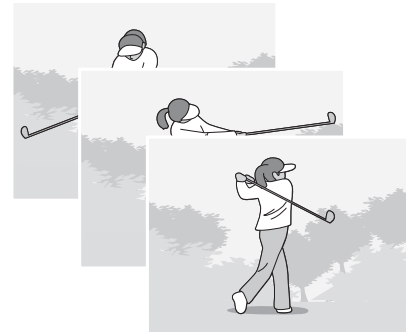

S (Stream)-CONT

With just one full-press of the shutter release button, you can take 16 consecutive shots at intervals of 1/7.5 seconds in about 2 seconds.

The 16 still images are grouped together as a set and are recorded as one image file (3072 × 2304 pixels).

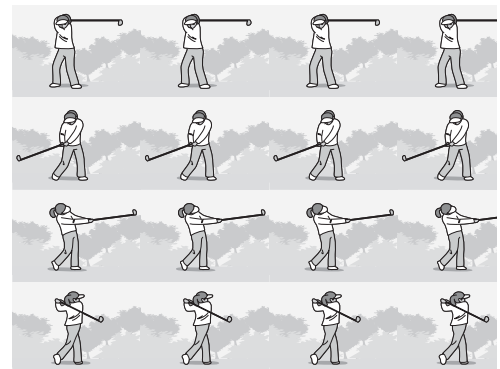

M (Memory-reversal)-CONT

The camera memorizes the scene while you hold down the shutter release button, and once you release it, the previous 2 seconds of shots are recorded.

The 16 still images are grouped together as a set and are recorded as one image file (3072 × 2304 pixels).

(2) The camera records the previous (approx.) 2 seconds

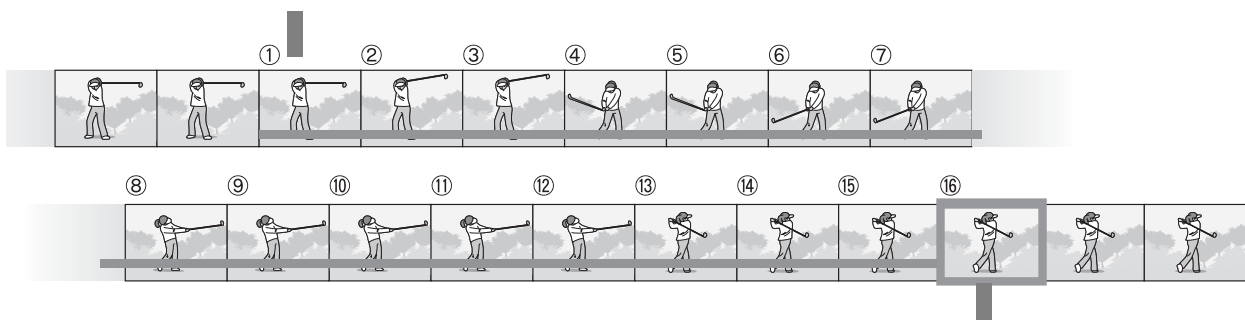

(1) If you release the shutter release button here...



Note -----

- When shooting with S-CONT or M-CONT, the ISO setting is fixed at [AUTO] even if it is set to [ISO 64] or [ISO 100].
- The maximum number of images that can be shot in the Multi-shot mode depends on the image size setting.
- The numbers of images that can be shot in the Multi-shot mode with the internal memory are as shown in the table below.

Image Size	Number of Multi-shot mode shots
3072 × 2304, 3072 × 2048, 2592 × 1944, 2048 × 1536	6
1280 × 960, 640 × 480	10

1 Switch the mode selector to .

2 Press the MENU/OK button.

- The shooting setting menu is displayed.

3 Press the ▼ button to select [CONT. MODE] and press the ► button.

4 Press the ▲▼ buttons to select [CONT.], [S-CONT], or [M-CONT].



5 Press the MENU/OK button, or ◀ button and press the MENU/OK button.

- The symbol appears on the screen.





CONT.

6 Compose your picture and then press and hold the shutter release button.

- Pictures continue to be taken for as long as you hold down the shutter release button.

7 Release your finger from the shutter release button to stop taking pictures.

- To playback consecutive images shot in Multi-shot mode, switch the camera to playback mode (P.46) and select the still image you want to play back with the buttons.



S-CONT (S Multi-Shot)

6 Compose your picture and then press the shutter release button.

- 16 pictures are taken automatically.



M-CONT (M Multi-Shot)

6 Compose your picture and then press and hold the shutter release button.

- The camera memorizes the scene while you hold down the shutter release button.

7 Release your finger from the shutter release button.

- The camera stops shooting and the 16 still images (in the previous 2 seconds) are recorded as one still image.



Note -----

- To return to normal single-image shooting, follow Steps 1 to 3, select [OFF] in Step 4, and press the MENU/OK button.
- In M-CONT mode, if you release the shutter release button within 2 seconds from the time you first pressed it, the shots from the time you pressed the shutter until you released it are recorded and the number of consecutive shots will be less than 16.
- The flash is turned off.
- The camera shake correction function cannot be used during Multi-shot shooting. If Multi-shot shooting is set while the camera shake correction function is turned on, changes to . (P.93)

Viewing an S-CONT or M-CONT Still Image in Enlarged Display Mode

While a still image (16 frames in an image file) taken with S-CONT or M-CONT is displayed, you can enlarge any one of the 16 frames. You can also switch between frames while viewing the image in enlarged display mode.

To view a frame from an S-CONT or M-CONT still image in enlarged display mode, follow the steps below.



1 Press the (Playback) button.

- The last shot taken is displayed.

2 Press the buttons to display an S-CONT or M-CONT still image.



3 Turn the zoom lever toward (Enlarged View).

- The first frame of the consecutive images is displayed in enlarged display mode. The frame position bar appears at the bottom of the screen.
- Press the   buttons to switch frames. To return to the 16-frame display, press the MENU/OK button.

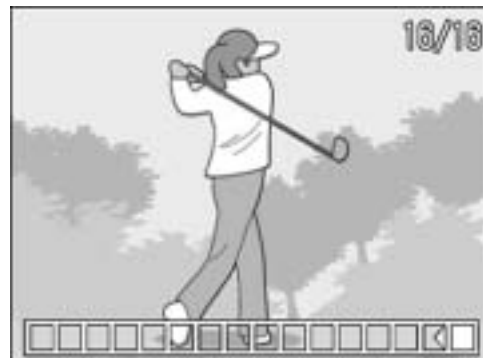

Note

Press the DISP. button to switch between displaying the bar at the bottom of the screen, displaying the grid guide, and hiding the display. (👉 P.55)

Setting the Color Depth (COLOR DEPTH)

You can set the color depth of still images to [NORMAL], [VIVID], or [NEUTRAL].

- 1** Switch the mode selector to .
- 2** Press the MENU/OK button.
 - The shooting setting menu is displayed.
- 3** Press the ▼ button to select [COLOR DEPTH] and press the ► button.
- 4** Press the ▲▼ buttons to select the desired setting.
- 5** Press the MENU/OK button, or ◀ button and press the MENU/OK button.
 - If you selected a setting other than [NORMAL], the symbol appears on the screen.

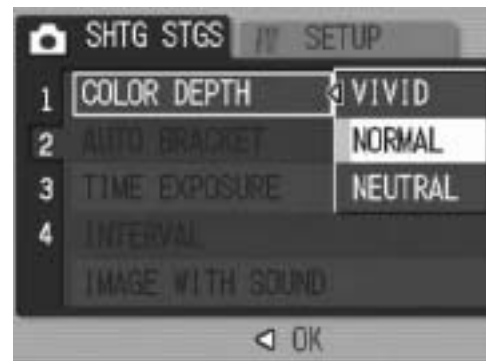

Shooting Consecutively with Different Exposures (AUTO BRACKET)

The auto bracketing function automatically shoots three consecutive shots at three exposure levels (-0.5EV, ± 0 , and +0.5EV) based on the set exposure level.

1

Various Shooting Functions



Note

This function is not available when shooting with sound.

1

Switch the mode selector to .

2

Press the MENU/OK button.

- The shooting setting menu is displayed.

3

Press the  button to select [AUTO BRACKET] and press the  button.

4

Press the   buttons to select [ON].

5

Press the MENU/OK button, or  button and press the MENU/OK button.

- [AB] appears on the screen.

6

Press the shutter release button to shoot the subject.

- Three consecutive shots are taken at -0.5EV, ± 0 , and +0.5EV based on the set exposure compensation setting. When shooting is completed, three still images are displayed on the LCD monitor. They are, from left to right, at -0.5EV (darker), standard exposure compensation setting, and +0.5EV (brighter).



Note

The exposure compensation can be changed using the shooting setting menu. (P.86)

Shooting Consecutively with Different White Balance (WB-BKT)

The white balance bracket function automatically records three images - a reddish image, a bluish image, and an image of the current white balance.

This is useful if you cannot determine the appropriate white balance.

- 1** Switch the mode selector to .
- 2** Press the MENU/OK button.
 - The shooting setting menu is displayed.
- 3** Press the ▼ button to select [AUTO BRACKET] and press the ► button.
- 4** Press the ▲▼ buttons to select [WB-BKT].



- 5** Press the MENU/OK button, or ◀ button and press the MENU/OK button.

- The symbol appears on the screen.

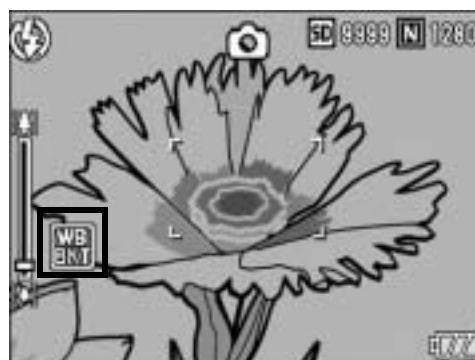



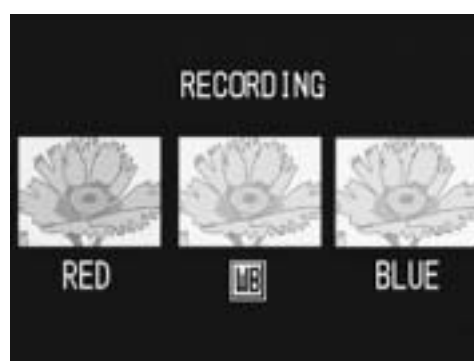

- 6** Press the shutter release button to shoot the subject.

- Three images (a reddish image, an image equal to the current white balance, and a bluish image) are automatically recorded.





Note

- This function is not available for Multi-shot ( P.73) or auto bracket shooting ( P.78).
- The flash cannot be used.
- [TIME EXPOSURE] ( P.81) is set to [OFF].
- The white balance can be changed using the shooting setting menu. ( P.87)

Using Long Time Exposure (TIME EXPOSURE)

You can select [1 SEC.], [2 SEC.], [4 SEC.], or [8 SEC.] for time exposure.

By using long time exposure, you can capture the movement of moving subjects such as the trail of fireworks and car lights when shooting a night scene.

1 Switch the mode selector to .

2 Press the MENU/OK button.

- The shooting setting menu is displayed.

3 Press the ▼ button to select [TIME EXPOSURE] and press the ► button.

4 Press the ▲▼ buttons to select the desired setting.





5 Press the MENU/OK button, or ◀ button and press the MENU/OK button.

- The setting appears on the screen.



Note

- When using long time exposure, the shutter speed may slow down and images may be blurred. Hold the camera steady by using a tripod when shooting.
- The camera shake correction function cannot be used when using long time exposure. If long time exposure is set while the camera shake correction function is turned on,  changes to .
- While shooting with long time exposure, the LCD monitor turns off.
- When time exposure is set, the function to remove noise from images operates. Therefore, up to four additional seconds may be required in addition to the time set for time exposure.

Shooting Pictures Automatically at Set Intervals (INTERVAL)

You can set the camera to automatically take pictures at fixed intervals.

You can set the shooting interval from 5 seconds to 3 hours in increments of 5 seconds.

1 Switch the mode selector to .

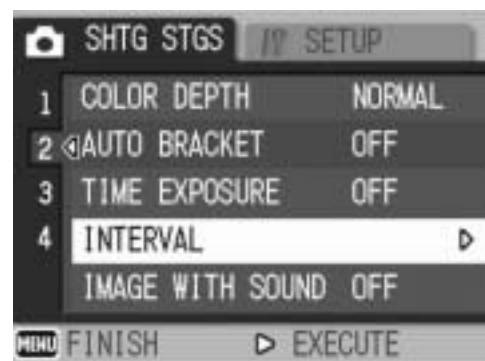

2 Press the MENU/OK button.
• The shooting setting menu is displayed.

3 Press the  button to select [INTERVAL] and press the  button.



4 Press the   buttons to set the hours.

5 Press the  button to move to the minutes setting, then use the   buttons to set the minutes.

- You can press and hold either the   buttons to quickly raise or lower the minute setting.

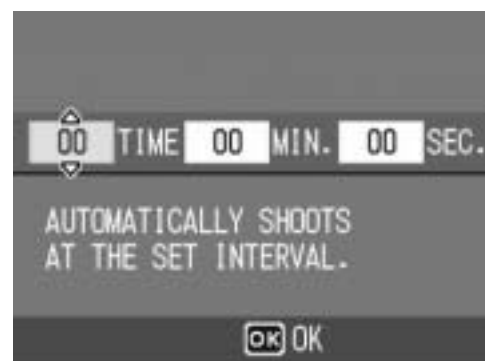

6 Press the  button to move to the seconds setting, then use the   buttons to set the seconds.

7 Press the MENU/OK button.
• [INTERVAL] appears on the screen.

8 Press the shutter release button to shoot the subject.
• A picture is taken every time the fixed interval elapses.



9 To stop shooting, press the MENU/OK button.



Caution-----

- The interval shooting setting is cleared when the camera is turned off.
- The time until the next picture can be taken according to the shooting menu setting may be longer than the time set for interval shooting. In this case, the shooting interval becomes longer than the set time.



Note-----

- Depending on the remaining battery level, the battery may become depleted during interval shooting.
- If you press the shutter release button during interval shooting, the camera shoots as usual. However, the interval shooting setting is unaffected. After shooting, once the time specified in interval shooting elapses, the next shot is taken.
- When interval shooting is turned on, Multi-shot is automatically set to [OFF] even if it had been set to [CONT.] or [M-CONT].

Shooting a Still Image with Sound (IMAGE WITH SOUND)

You can shoot a still image with a voice memo of up to eight seconds.

1 Switch the mode selector to .

2 Press the MENU/OK button.

- The shooting setting menu is displayed.

3 Press the ▼ button to select [IMAGE WITH SOUND] and press the ► button.

4 Press the ▲▼ buttons to select [ON].



5 Press the MENU/OK button, or ◀ button and press the MENU/OK button.

- The symbol appears on the screen.

6 Press the shutter release button to shoot the picture.

- The camera starts recording after shooting.



7 Press the shutter release button to finish recording.

- Even if the shutter release button is not pressed, recording automatically stops after 8 seconds.



Note

- To play back a still image with sound, display the still image in the same way as a still image without sound (👉 P.46) and press the ADJ. button to play back the sound.
- Press the ▲▼ buttons during sound playback to display the volume adjustment bar. You can adjust the volume with the ▲▼ buttons.

Inserting the Date into a Still Image (DATE IMPRINT)



You can insert the date (YY/MM/DD) or the date and time (YY/MM/DD hh:mm) at the lower right of a still image.

- 1** Switch the mode selector to .
- 2** Press the MENU/OK button.
 - The shooting setting menu is displayed.
- 3** Press the ▼ button to select [DATE IMPRINT] and press the ► button.
- 4** Press the ▲▼ buttons to select the desired setting.



- 5** Press the MENU/OK button, or ◀ button and press the MENU/OK button.
 - The symbol appears on the screen.



-  **Note** -----
- If the date and time have not been set, [DATE IMPRINT] cannot be used. First make the date and time settings ( P.146).
 - [DATE IMPRINT] cannot be used with movies.

Changing the Exposure (EXPOSURE COMP.)

1

Various Shooting Functions

The exposure setting enables you to select the brightness level for your picture. Normally, if your subject is centered, backlight compensation is automatically activated, and you can shoot with the correct exposure.

In the following cases, or when you intentionally want to change the exposure, you can adjust the exposure setting. Exposure can be specified in the range from -2.0 to +2.0. Setting the level higher (+) makes the picture brighter and lower (-) makes the picture darker.

For backlighting

When the background is particularly bright, the subject will appear dark (underexposed). In this case, set the exposure level higher (+).

When your subject is whitish

The entire picture will turn out dark (underexposed). Set the exposure level higher (+).





When your subject is darkish

The entire picture will turn out bright (overexposed). Set the exposure level lower (-).

The same happens when you take a photo of a subject in a spotlight.

To change the setting, use the shooting setting menu or the ADJ. button. This section explains easy ways to change the setting with the ADJ. button. You can also change the function assigned to the ADJ. button. (👉 P.136)

To use the shooting setting menu, see "Using the Menu" (👉 P.65).

- 1 Switch the mode selector to .**
- 2 Press the ADJ. button and then press the   buttons until the exposure compensation bar appears.**
- 3 Press the   buttons to set the exposure setting.**
 - You can also press the shutter release button to take a picture.
- 4 Press the MENU/OK button.**
 - The setting appears on the screen.









Note

When shooting in particularly bright places, you may not be able to correct the exposure level. In that case, the [!AE] symbol appears on the screen.

Using Natural and Artificial Lighting (WHITE BALANCE)

Adjust the white balance so that a white subject will appear white. At purchase, the white balance is set to [AUTO]. Normally you do not need to change the setting, but if the camera is having difficulty determining the white balance when shooting an object of a single color or when shooting under multiple light sources, you can change the setting.

White Balance Modes

Symbol	Mode	Description
AUTO	AUTO	Adjusts the white balance automatically.
	OUTDOORS	Select this when shooting outdoors (sunny) and white balance fails to adjust properly.
	CLOUDY	Select this when shooting in cloudy weather or shade and the white balance fails to adjust properly.
	INCANDESCENT LAMP	Select this when shooting under incandescent light and white balance fails to adjust properly.
	INCANDESCENT LAMP2	Select this when shooting under incandescent light (more reddish, compared with [INCANDESCENT LAMP]).
	FLUORESCENT LAMP	Select this when shooting under fluorescent light and white balance fails to adjust properly.
	MANUAL SETTINGS	Adjust the white balance manually.

To change the setting, use the shooting setting menu or the ADJ. button. This section explains easy ways to change the setting with the ADJ. button. You can also change the function assigned to the ADJ. button. (👉 P.136)

To use the shooting setting menu, see "Using the Menu" (👉 P.65).

- 1** Switch the mode selector to .
- 2** Press the ADJ. button and then press the ◀▶ buttons until the white balance menu appears.
- 3** Press the ▲▼ buttons to select a setting other than [M].
 - You can also press the shutter release button to take a picture.

4 Press the MENU/OK button.

- The symbol appears on the screen.



Note

- The white balance may not be adjusted correctly for a subject that is mostly dark. In this case, add something white to the subject.
- When shooting with the flash, the white balance may not be adjusted correctly if [AUTO] is not selected. In this case, switch to [AUTO] to shoot with the flash.

Setting the White Balance Manually (MANUAL SETTINGS)

- 1 Switch the mode selector to .
- 2 Press the ADJ. button and then press the ◀▶ buttons until the white balance menu appears.
- 3 Press the ▲▼ buttons to select [M].
- 4 Point the camera at a piece of paper or something white under the lighting conditions for your picture.
- 5 Press the DISP. button.
 - The white balance is set.
- 6 Press the MENU/OK button.
 - The symbol appears on the screen.
 - The screen is displayed with the white balance set in Step 5. If the result is not as expected, repeat Steps 4 and 5 to change the settings as many times as required.



Note

To cancel [MANUAL SETTINGS], select a setting other than [M] in Step 3.

Changing the Sensitivity (ISO SETTING)

ISO sensitivity indicates how sensitive film is to light. A greater value means higher sensitivity. High sensitivity is suitable for shooting an object in a dark place or a fast-moving object while minimizing blurring.

You can select from the following ISO settings:

AUTO, AUTO-HI, ISO 64, ISO 100, ISO 200, ISO 400, ISO 800, and ISO 1600.

When ISO setting is set to [AUTO], the camera automatically changes the sensitivity according to the distance, brightness, zoom, macro settings, and picture quality/size. Usually, use the camera in the [AUTO] mode.

When the ISO setting is set to [AUTO-HI] (auto high sensitivity), the sensitivity is automatically set according to the shooting conditions but at a higher sensitivity than in [AUTO]. When shooting a dark subject, the shutter speed set in [AUTO-HI] is faster than in [AUTO], which may reduce camera shake or blurring of the subject. In [AUTO-HI], the sensitivity is automatically increased to the ISO sensitivity set in the SETUP menu. (☞ P.130)

If you do not want to allow the camera to change the ISO sensitivity, select an ISO setting other than [AUTO] or [AUTO-HI].

To change the setting, use the shooting setting menu or the ADJ. button. This section explains easy ways to change the setting with the ADJ. button. You can also change the function assigned to the ADJ. button. (☞ P.136)

To use the shooting setting menu, see "Using the Menu" (☞ P.65).

- 1** Switch the mode selector to .
- 2** Press the ADJ. button and then press the ◀▶ buttons until the ISO menu appears.
- 3** Press the ▲▼ buttons to select the desired setting.



4 Press the MENU/OK button, or ◀ button and press the MENU/OK button.

- The setting appears on the screen.



Note -----

- When the ISO setting is set to [AUTO], the sensitivity is equivalent to ISO 400 if the flash is used. When the image size is 3072 × 2304, the sensitivity is equivalent to ISO 80 if the flash is not used.
- Images shot with a higher sensitivity may appear grainy.

Limiting the Shutter Speed (SLOW SHUTTER LMT)

The maximum shutter speed can be limited to the following:
1/8 second, 1/4 second, and 1/2 second.

When this function is set to [OFF], the maximum shutter speed varies depending on the ISO setting.

- 1** Switch the mode selector to .
- 2** Press the MENU/OK button.
 - The shooting setting menu is displayed.
- 3** Press the ▼ button to select [SLOW SHUTTER LMT] and press the ► button.
- 4** Press the ▲▼ buttons to select the desired setting.
- 5** Press the MENU/OK button, or ◀ button and press the MENU/OK button.
 - The setting appears on the screen.



-  **Note** -----
- When time exposure is set to [ON], priority is given to time exposure.
 - When scene mode is set to [NIGHTSCAPE], priority is given to the maximum shutter speed in [NIGHTSCAPE].
 - When the flash is set to [FLASH SYNCHRO.], the longest shutter speed is one second.
 - When using the slow shutter limit, the light quantity may be insufficient depending on the brightness of the subject, resulting in a dark image. In this case, try the following:
 - Selecting a greater slow shutter limit.
 - Raising the ISO setting. (👉 P.90)
 - Using the flash. (👉 P.37)

Using the Camera Shake Correction Function to Prevent Camera Shake (CAMERA SHAKE COR)

You can prevent camera shake by turning on the camera shake correction function.

At the time of purchase, the camera shake correction function is turned on.

- 1** Switch the mode selector to .
- 2** Press the MENU/OK button.
 - The shooting setting menu is displayed.
- 3** Press the ▼ button to select [CAMERA SHAKE COR] and press the ► button.
- 4** Press the ▲▼ buttons to select [ON].

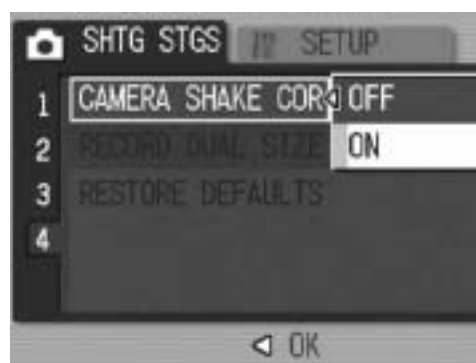





- 5** Press the MENU/OK button, or ◀ button and press the MENU/OK button.

- The symbol appears on the screen.



Caution

- The camera shake correction function is not available during Multi-shot shooting, long time exposure and movie shooting. If Multi-shot shooting or long time exposure is set while the camera shake correction function is turned on,  changes to .  disappears when  [MOVIE] is selected from the scene mode.
- The camera shake correction function cannot prevent movement of the shooting subject (caused by wind, etc.).
- Effects of the camera shake correction function vary depending on the surroundings.



Note

The  mark appears when camera shake is likely to occur. ( P.30)

Shooting a Still Image with a Subfile (RECORD DUAL SIZE)

When shooting a still image with [RECORD DUAL SIZE] set to [ON], the original still image is saved along with a subfile. You can use [SUB FILE SIZE] in the SETUP menu to select the size of the subfile. (P.131)

- 1 Switch the mode selector to .
- 2 Press the MENU/OK button.
 - The shooting setting menu is displayed.
- 3 Press the ▼ button to select [RECORD DUAL SIZE] and press the ► button.
- 4 Press the ▲▼ buttons to select [ON].



- 5 Press the MENU/OK button, or press the ◀ button and then the MENU/OK button.
 - The symbol appears on the screen.



- Caution**-----
- A subfile is created when the size of the original image is 3072 × 2304, 3072 × 2048, 2592 × 1944, 2048 × 1536, or 1280 × 960.
 - If the size of the subfile is set to the same size as the original still image, no subfile is saved even if [RECORD DUAL SIZE] is set to [ON]. (P.131)
 - This function is not available when shooting with CONT., AUTO BRACKET, IMAGE WITH SOUND, or when scene mode is set to [SKEW CORRECTION].

Returning the Shooting Setting Menu Settings to their Defaults (RESTORE DEFAULTS)

To return the shooting setting menu settings to their defaults, follow the steps below.

1 Switch the mode selector to .

2 Press the MENU/OK button.

- The shooting setting menu is displayed.

3 Press the ▲▼ buttons to select [RESTORE DEFAULTS] and press the ► button.

4 Make sure that [YES] is selected, and then press the MENU/OK button.

- The display indicates the camera is restoring the initial settings. Once it is finished, the display returns to the shooting mode screen.



Note

For a list of functions whose settings are saved when the camera is turned off, see "Appendices". (👉 P.180)

2 Shooting/Playing Back Movies

Shooting Movies

You can shoot movies with sound.

You can set the image size to 640 × 480, 320 × 240, or 160 × 120 pixels.

You can set the number of frames shot per second (frame rate) to either 30 or 15.

Each movie you shoot is recorded as an AVI file.

2

Shooting/Playing Back Movies

1 Switch the mode selector to **SCENE (scene mode)**.

- The camera is ready to shoot and the selected scene mode is displayed at the top of the LCD monitor.

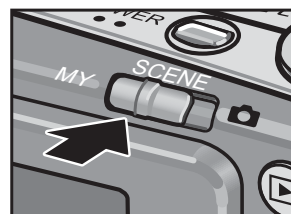

2 Press the **MODE** button.

- The scene mode selection screen appears.

3 Press **▲▼◀▶** button to select **[MOVIE]**.

4 Press the **MENU/OK** button.



5 Press the shutter release button.

- The camera starts recording. Recording continues until you press the shutter release button again.

6 Press the shutter release button to finish recording the movie.



Caution-----

- While shooting movies, operation sounds may be recorded.
- The maximum recording time per shooting depends on the size of your SD memory card. (👉 P.98) Even if you are within the maximum recording time, recording may end depending on your card.
- The camera shake correction function does not work in movie mode. When  [MOVIE] is selected from the scene mode while the camera shake correction function is on,  disappears from the LCD monitor.

**Note**

- The flash cannot be used.
- While shooting movies, only digital zoom can be used. (👉 P.35)
- When the shutter release button is pressed in Step 5, the camera focuses on the subject.
- The remaining recording time may not change uniformly because it is recalculated from the remaining memory capacity during movie recording.
- Use the shooting setting menu to set the image size (👉 P.66) and frame rate (👉 P.97) of movies.
- The shooting setting menu items for movie mode differ from those in Still Image Mode. (👉 P.64)
- A high speed memory card is recommended when shooting for long periods.

Setting the Frame Rate (FRAME RATE)

You can select the number of shot frames per second (frame rate) in movie mode.

- 1** Select [MOVIE] from the scene mode.
- 2** Press the MENU/OK button.
 - The shooting setting menu is displayed.
- 3** Press the ▼ button to select [FRAME RATE] and press the ► button.
- 4** Press the ▲▼ buttons to select [30FPS] or [15FPS].
- 5** Press the MENU/OK button, or ◀ button and press the MENU/OK button.
 - The setting appears on the screen.

**Movie Frames**

Movies consist of many frames whose images appear to be moving when displayed at high speed.



Note -----

- Movie recording time may vary depending on the capacity of the recording destination (internal memory or SD memory card), shooting conditions, and the type and manufacturer of the SD memory card.
- The table below shows the approximate recording time.

	Internal Memory	64 MB	128 MB	256 MB	512 MB	1 GB	2 GB
640 × 480 (15 FPS)	51 s	57 s	1 min	3 min	7 min	14 min	30 min
			56 s	51 s	46 s	57 s	24 s
640 × 480 (30 FPS)	26 s	28 s	58 s	1 min	3 min	7 min	15 min
				56 s	55 s	31 s	19 s
320 × 240 (15 FPS)	2 min	2 min	5 min	11 min	24 min	46 min	94 min
	40 s	58 s	59 s	57 s	5 s	19 s	11 s
320 × 240 (30 FPS)	1 min	1 min	3 min	6 min	12 min	23 min	48 min
	22 s	31 s	4 s	7 s	19 s	42 s	13 s
160 × 120 (15 FPS)	9 min	10 min	21 min	41 min	84 min	162 min	330 min
	23 s	25 s	3 s	58 s	33 s	36 s	42 s
160 × 120 (30 FPS)	5 min	5 min	11 min	22 min	46 min	88 min	180 min
	6 s	40 s	27 s	50 s	1 s	31 s	2 s





Playing Back Movies

To playback movies, follow the steps below.

1 Press the (Playback) button.

- The last shot taken is displayed.
- The first frame of the movie is displayed as a still image.









2 Select the movie you want to view using the buttons.

- Press the  button to display the next file.
- Press the  button to display the previous file.
- Press the  button to display the file 10 frames backward.
- Press the  button to display the file 10 frames forward.



3 Press the ADJ. button.

- Playback begins.
The elapsed playback indicator or the elapsed time is displayed on the screen.

Fast Forward	Turn the zoom lever toward  during playback.
Rewind	Turn the zoom lever toward  during playback.
Pause/Playback	Press ADJ.button.
Slow Playback	Turn and hold the zoom lever toward  during pause.
Slow Rewind	Turn and hold the zoom lever toward  during pause.
Next Frame	Turn the zoom lever toward  during pause.
Previous Frame	Turn the zoom lever toward  during pause.
Volume Adjustment	Press the   buttons during playback.

3 Other Playback Functions

Playback Setting Menu

Press the MENU/OK button in playback mode to display the playback setting menu. The playback setting menu allows you to make the settings for the following functions.

Setting	Options	Refer to
SLIDE SHOW	_____	P.101
PROTECT	Select/Cancel 1 FILE, Select/Cancel ALL FILES, Select Multi-files	P.102
DPOF	Select/Cancel 1 FILE, Select/Cancel ALL FILES, Select Multi-files	P.105
RESIZE	1280, 640	P.108
COPY TO CARD	_____	P.109
SKEW CORRECTION	_____	P.110
RECOVER FILE	_____	P.112







Note

The SETUP menu can be accessed from within the playback setting menu. (P.121)

Using the Menu

This explains how to make the settings.

- 1 Press the  (Playback) button to select the playback mode.**
- 2 Press the MENU/OK button.**
 - The playback setting menu appears.
- 3 Press the   buttons to select the desired item.**
- 4 Press the  button.**
 - The screen for the selected menu item appears.



Displaying Photos in Order Automatically (SLIDE SHOW)

You can display the recorded still images and movie files sequentially on the screen. This is called a slide show. To view a slide show, follow the steps below.

1 Press the  (Playback) button.

- The last shot taken is displayed.

2 Press the MENU/OK button.

- The playback setting menu appears.

3 Press the  button to select [SLIDE SHOW] and press the  button.

- The slide show starts and files are played back in order.
- If you want to stop the slide show in progress, press any button on the camera.
The slide show repeats itself until stopped.



Note -----

- Each still image is displayed for three seconds.
- For movies, not just one frame, but the entire movie you shot is played back.
- If a still image has a voice memo, the voice memo is also played back.

Write-protecting Files (PROTECT)

You can protect files from being accidentally deleted.



Caution

Protected files cannot be deleted normally. However, they will be deleted if you format the memory where the files are stored.

Protecting a File

1 Press the (Playback) button.

- The last shot taken is displayed.

2 Press the buttons to display the file you want to protect.

3 Press the MENU/OK button.

- The playback setting menu appears.

4 Press the button to select [PROTECT] and press the button.

5 Make sure that [1 FILE] is selected, and then press the MENU/OK button.

- The selected file is protected and the  symbol appears on the screen.



Note

To unprotect a file, display the file you want to unprotect and perform Steps 3 to 5.

Protecting All Files

To protect all your files, follow the steps below.

1 Press the  (Playback) button.

2 Press the MENU/OK button.

- The playback setting menu appears.

3 Press the  button to select [PROTECT] and press the  button.

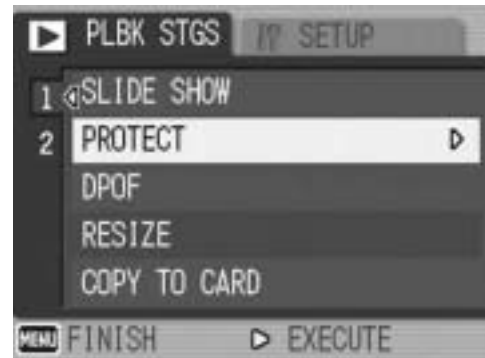

4 Press the   buttons to select [ALL FILES].

5 Make sure that [SELECT] is selected, and then press the MENU/OK button.

- All files are protected and the symbol appears on the screen.



Note

To cancel protection for all protected files, select [CANCEL] in Step 5.

Protecting Multiple Files at Once

To protect selected files all at once, follow the steps below.

1 Press the  (Playback) button.

2 Turn the zoom lever toward  (Thumbnail Display) twice.

- The screen is divided into 12 frames and thumbnails are displayed.

3 Press the     buttons to select the first file you want to protect.





4 Press the MENU/OK button.

- The playback setting menu appears.

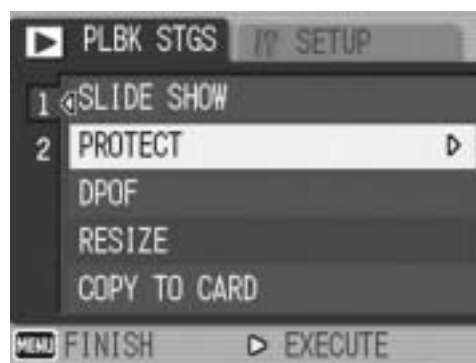
5 Press the  button to select [PROTECT] and press the  button.

- The Protect symbol appears in the upper-right corner of the file.



6 Press the     buttons to select the next file you want to protect, and then press the MENU/OK button.

7 Repeat Step 6 to select all the files you want to protect.

- If you selected a file by mistake, you can deselect by selecting the file and pressing the MENU/OK button again.

8 Press the DISP. button.

- The display indicates that the selected images are being processed; once finished, the display returns to the thumbnail display screen.



Note





- To unprotect multiple files, follow the same steps described above to select the files to unprotect, and then press the DISP. button.
- You can also unprotect all files at once. (P.103)
- For information on thumbnail display, see P.48.

Using a Printing Service (DPOF)

The still images recorded on an SD memory card can be printed out if you take them to a store that offers a digital camera print service. To use a print service, you must make print settings on your camera. These settings are called Digital Print Order Format (DPOF) settings.

The DPOF setting specifies one print per still image. You can also select multiple images for the DPOF setting and specify the number of copies to print.

Setting DPOF for the Displayed Still Image

- 1** Press the  (Playback) button.
- 2** Press the  buttons to display the still image for which you want to make the DPOF setting.
- 3** Press the MENU/OK button.
 - The playback setting menu appears.
- 4** Press the  button to select [DPOF] and press the  button.
- 5** Make sure that [1 FILE] is selected, and then press the MENU/OK button.
 - Once the DPOF setting is made, the DPOF symbol appears on the screen.



Note

To remove the DPOF setting, display the still image with the DPOF setting and perform Steps 3 to 5.

Setting DPOF for All Still Images

To apply DPOF settings to all your still images, follow the steps below.

1 Press the  (Playback) button.

2 Press the MENU/OK button.

- The playback setting menu appears.

3 Press the  button to select [DPOF] and press the  button.

4 Press the   buttons to select [ALL FILES].

5 Make sure that [SELECT] is selected, and then press the MENU/OK button.

- Once the DPOF setting is made, the DPOF symbol appears on the screen.

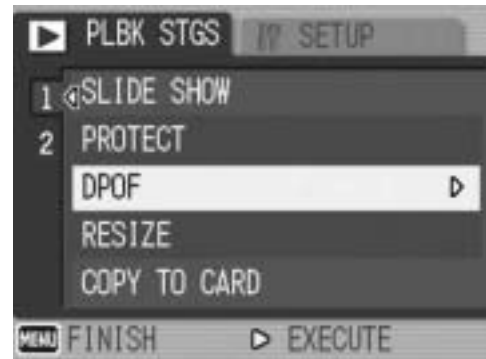













Note

To cancel the DPOF settings for all still images with DPOF settings, select [CANCEL] in Step 5.

Setting DPOF for Multiple Still Images

To make the DPOF settings for selected still images all at once, follow the steps below.

- 1** Press the  (Playback) button.
- 2** Turn the zoom lever toward  (Thumbnail Display) twice.
 - The screen is divided into 12 frames and thumbnails are displayed.
- 3** Press the  buttons to select the first still image for which you want to make the DPOF setting.
- 4** Press the MENU/OK button.
 - The playback setting menu appears.
- 5** Press the  button to select [DPOF] and press the  button.
- 6** Press the  buttons to set the number of copies to print.
 - Press the  button to increase the number of copies, or press the  button to decrease the number of copies.
- 7** Press the  buttons to select the next still image for which you want to make the DPOF setting.
- 8** Press the  buttons to set the number of copies to print.
 - Press the  button to increase the number of copies, or press the  button to decrease the number of copies.
- 9** Repeat Steps 7 and 8 to select all the still images for which you want to make the DPOF setting.
- 10** Press the MENU/OK button.
 - The display indicates that the selected images are being processed; once finished, the display returns to the thumbnail display screen.



Note

- To remove the DPOF settings for multiple still images, follow the same steps described above to set the number of copies to print to [0] for each image, and then press the MENU/OK button.
- You can also cancel the DPOF settings for all still images at once. (👉 P.106)

Changing the Image Size (RESIZE)

You can reduce the image size of a shot still image to create a new file with a different image size.

Original	Resized	
F3072/N3072/F3:2/F2592/N2592/F2048/N2048	N1280	N640
F1280/N1280	N640	



Caution

You can resize only still images and still images with voice memos. Movies cannot be resized.



Note

- The ratio of width to height of [F3:2] images is 3:2. When an image of this type is resized, it is reduced to a 4:3 image with black borders at the top and bottom.
- You can also change the image size during shooting. (P.66)

To change the image size, follow the steps below.

1

Press the  (Playback) button.

2

Press the     buttons to display the file with the image size you want to change.

3

Press the MENU/OK button.

- The playback setting menu appears.

4

Press the  button to select [RESIZE] and press the  button.



5

Press the   buttons to select [1280] or [640].

6

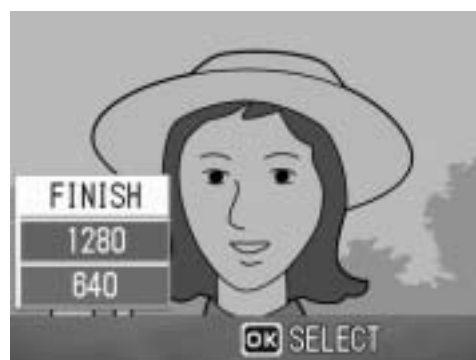

Press the MENU/OK button.

- The display indicates that the image is being resized, and then the resized image is recorded.



Copying the Contents of the Internal Memory to an SD Memory Card (COPY TO CARD)

You can copy all movies, still images, and sound data stored in the internal memory onto an SD memory card at once.

- 1** Turn the camera off.
- 2** Insert an SD memory card.
- 3** Turn the camera on.
- 4** Press the  (Playback) button.
- 5** Press the MENU/OK button.
 - The playback setting menu appears.
- 6** Press the  button to select [COPY TO CARD] and press the  button.
 - The display indicates copying is in progress; once finished, the display returns to the playback screen.

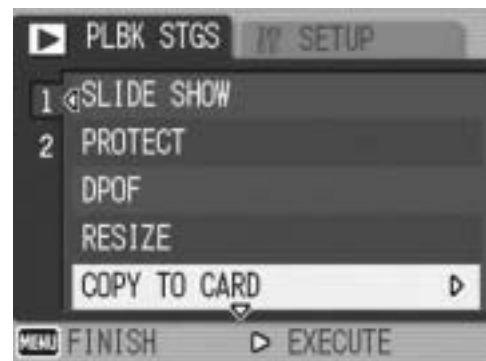

Note

- If the capacity of the SD memory card to which you are copying is insufficient, a message will be displayed indicating there is not enough capacity. To copy only the number of shots that will fit into the available capacity, select [YES] and then press the MENU/OK button. To cancel copying, select [NO] and then press the MENU/OK button.
- It is not possible to copy the contents of an SD memory card to the internal memory.

Straightening Skewed Images (SKEW CORRECTION)



You can straighten rectangular objects, such as a message board or business card, shot at an angle, to make them look as if they were shot squarely.



1 Press the  (Playback) button.

2 Press the     buttons to display the file you want to straighten.

3 Press the MENU/OK button.

- The playback setting menu appears.

4 Press the  button to select [SKEW CORRECTION] and press the  button.

- The display indicates that the image is being processed, and then the area recognized as the correction range is displayed with an orange frame. Up to five areas can be recognized.
- If the target area cannot be detected, an error message appears. The image before correction remains recorded.
- To select another correction area, move the orange frame to the target area by pressing the  button.
- To cancel skew correction, press the  button. Even if you cancel skew correction, the image before skew correction remains recorded.



5 Press the MENU/OK button.

- The display indicates that the image is being corrected, and then the corrected image is recorded. The image before correction is also recorded.

**Caution**-----

Skew correction mode does not work with movies.

**Note**-----

- The image size does not change for skew corrected images.
- If the image size is large, skew correction will take time. Resize the image (👉 P.108) before performing skew correction to speed up the process.
- The following table shows the approximate time required for skew correction.

Image Size	Correction time
3072 × 2304	Approx. 33 seconds
2592 × 1944	Approx. 26 seconds
2048 × 1536	Approx. 15 seconds
1280 × 960	Approx. 6 seconds
640 × 480	Approx. 2 seconds

- When scene mode is set to [SKEW COR MODE], you can shoot an image and then immediately correct any skew in the image. (👉 P.40)

Restoring Deleted Files (RECOVER FILE)

You can restore all deleted files.

Deleted files cannot be restored after performing any of the following operations.

- Turning the camera off
- Switching from playback mode to shooting mode
- Using DPOF, RESIZE, COPY TO CARD, or SKEW CORRECTION.

1 Press the MENU/OK button.

- The playback setting menu appears.

2 Press the ▼ button to select [RECOVER FILE] and press the ► button.

- A screen appears to confirm whether to restore all files.
- If there are no restorable files, a confirmation message appears.

3 Press the ► buttons to select [YES] and then press the MENU/OK button.

- All deleted files are restored.



Viewing on a Television

You can view files you have taken on a TV screen. The camera displays everything on the TV screen just as it would on the LCD monitor.

To use your television for viewing, connect your camera to the television with the AV cable that came with your camera. To view files on a television, follow the steps below.

1 Securely connect the AV cable to the Video In terminal on the television.

- Connect the white plug of the AV cable to the audio input terminal (white) of the TV unit and the yellow plug to the video input terminal (yellow).

Video input terminal (yellow)

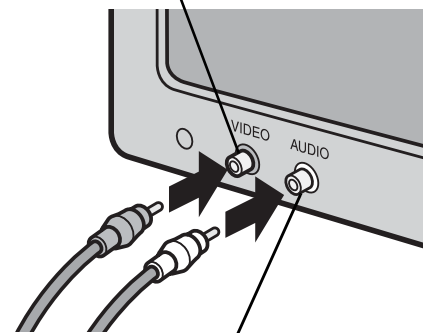

Audio input terminal (white)

2 Make sure that the camera is off.

3 Securely connect the AV cable to the AV output terminal on the camera.

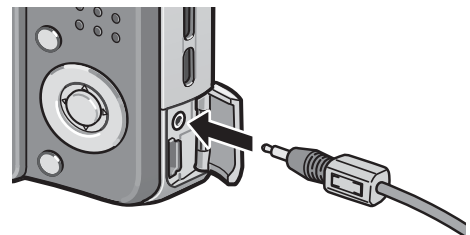

4 Set the television to Video mode. (Set the input to Video)

- For details, see the documentation that came with the television.

5 Press the POWER button or the (Playback) button for more than one second to turn the camera on.

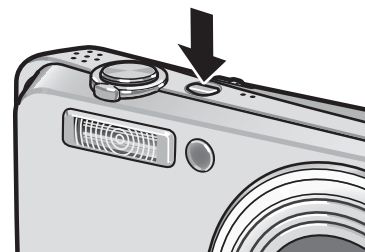

**Caution**-----

When the AV cable is connected to the camera, the LCD monitor and the speaker output turn off.

**Note**-----

- You can connect the AV cable to the Video In terminal on your video recorder and record what you have shot to a video recorder.
- Your camera is set to NTSC playback format (used in Japan and other countries) for use with television equipment and other audiovisual equipment. If the equipment you want to connect to uses PAL format (used in Europe and elsewhere), then switch your camera to PAL format in the SETUP menu before connecting. (👉 P.148)

Direct Print Function

The Direct Print standard enables direct printing from a camera to a printer by connecting them via a USB cable. Photos can be printed quickly and easily from your digital camera without using a computer.



Caution

You cannot print movies (AVI files) with this function. For still images with sounds (JPG files with WAV files), only the still images (JPG files) are printed.



Note

- This camera uses PictBridge, an industry standard for Direct Printing.
- Your printer must be compatible with PictBridge to use the Direct Print function. For support information, see the documentation that came with the printer.
- For some printers, Direct Print may not be available when [MASS STR] is selected for [USB CONNECTION] (P.142) in the SETUP menu of the camera. In such cases, select [ORIGINAL] instead.

Connecting the Camera to a Printer

Connect your camera to a printer using the USB cable provided.

1 Make sure that the camera is off.

2 Connect your camera to a printer using the USB cable provided.

- Turn on the printer if it is not already on.

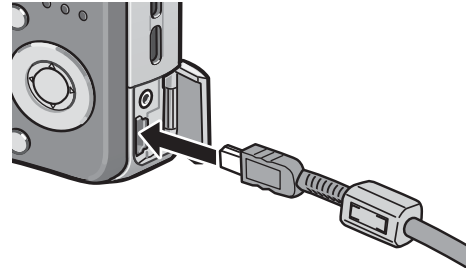

Note

To disconnect the camera from the printer, check that the power is off on both units before disconnecting the USB cable between them.

Printing Still Images

You can print still images from the camera with a PictBridge-compatible printer.

Still images are sent from the internal memory when no SD memory card is loaded or from an SD memory card when one is loaded.



Caution

Do not disconnect the USB cable during printing.



Note

If a [PRINTER ERROR] message appears during image transfer, check the printer status and take the appropriate action.

Printing One or All Still Images

1 Check that the printer is ready to print.

- The [CONNECTING...] screen appears.



2 Press the ADJ. button.

- The Direct Print playback mode screen appears.

3 Press the ▲▼◀▶ buttons to select an image for printing.

4 Press the ADJ. button.

5 Press the ▲▼ buttons to select [1 FILE] or [ALL FILES].

6 Press the MENU/OK button.

- The Direct Print menu appears.



7 Press the ▲▼ buttons to select an item, and then press the ► button to display the detailed options screen.

- When [CONNECTING...] is displayed, the connection to the printer is not yet established. When a connection is established, [CONNECTING...] disappears and [DIRECT PRINT] appears. Proceed with this step after the connection is established.
- The following items can be selected. Each item appears only when supported by the printer connected to the camera. The items marked with an asterisk (*) appear only when [REPORT PRINT] is supported by a Ricoh printer connected to the camera.

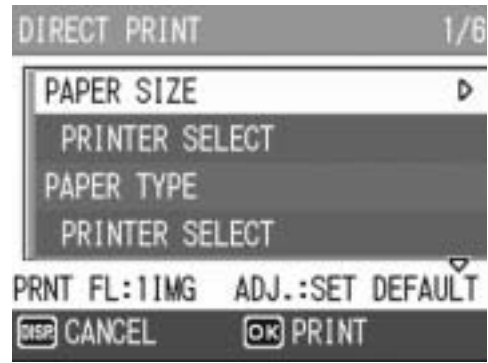

Item Name	Description
PAPER SIZE	Sets the paper size.
PAPER TYPE	Sets the paper type.
LAYOUT	Sets the number of images printed on a sheet of paper. The number of images that can be laid out on a sheet of paper varies depending on the connected printer.
DATE PRINT	Selects whether to print the date (shooting date). The date format can be set using the date/time option in the SETUP menu.
FILE NAME PRINT	Selects whether to print the file name.
OPTIMIZE IMAGE	Selects whether to optimize the image data (still image) prior to printing on the printer.
PRINT SIZE	Sets the print image size.
PRINT QUALITY	Sets the print quality.
REPORT PRINT*	Prints on forms.

8 Press the ▲▼ buttons to select the setting, and then press the MENU/OK button.

- The display returns to the Direct Print menu.

9 Repeat Steps 7 and 8 to change other settings as required.



Note

- To specify the settings as the default settings next time the camera is connected to the printer, press the ADJ. button when the screen in Step 7 is displayed. When the screen at the right appears, press the ◀▶ buttons to select [SET] and press the MENU/OK button.
- To use the settings last set the next time the camera is connected to the printer, select [CANCEL].



10 Press the MENU/OK button.

- The selected still images are sent to the printer and the [SENDING...] screen appears.
- Pressing the DISP. button cancels the operation.
- When the images have been sent to the printer, the display returns to the Direct Print playback mode screen and printing starts.

Printing Several Still Images

1 Check that the printer is ready to print.

- The [CONNECTING...] screen appears.

2 Press the ADJ. button.

- The Direct Print playback mode screen appears.

3 Turn the zoom lever toward (Thumbnail Display).

- The screen is divided into 12 frames and thumbnails are displayed.

4 Press the ▲▼◀▶ buttons to select an image for printing.

5 Press the MENU/OK button.

6 Press the ▲▼ buttons to set the number of copies to print.

- Press the ▲ button to increase the number of copies, or press the ▼ button to decrease the number of copies.

7 Press the ◀▶ buttons to select the next image for printing.

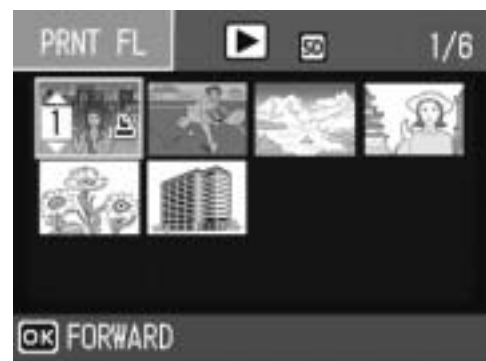
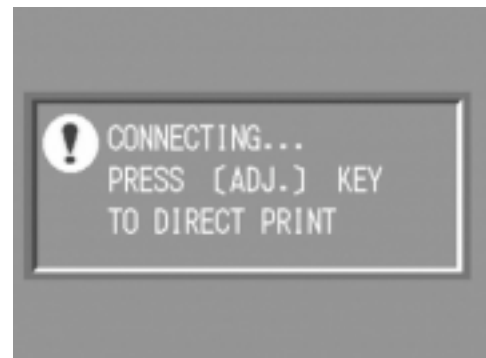

8 Press the ▲▼ buttons to set the number of copies to print.

9 Repeat Steps 7 and 8 to select all the still images to be printed and the number of copies for each.

10 Press the MENU/OK button.

- The Direct Print menu appears.

11 Press the ▲▼ buttons to select an item, and then press the ► button to display the detailed options screen.

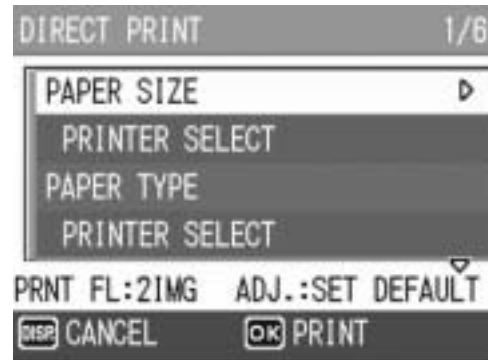

- When [CONNECTING...] is displayed, the connection to the printer is not yet established. When a connection is established, [CONNECTING...] disappears and [DIRECT PRINT] appears. Proceed with this step after the connection is established.
- For available settings, see P.118.

12 Press the ▲▼ buttons to select the setting, and then press the MENU/OK button.

- The display returns to the Direct Print menu.

13 Repeat Steps 11 and 12 to change other settings as required.

14 Press the MENU/OK button.

- The selected still images are sent to the printer and the [SENDING...] screen appears.
- Pressing the DISP. button cancels the operation.
- When all the selected still images have been sent from the camera to the printer, the camera display returns to the Direct Print playback mode screen.



Note

- Only images with a printer mark () are printed. If you cancel printing and then try to print again, make sure that the printer mark is on the images you want to print.
- The same still image can also be printed several times on a single sheet.
- The available items vary depending on the functions of the printer.
- To print images using the printer's default settings, select [PRINTER SELECT] on the detailed options screen.

5 Changing Camera Settings

SETUP Menu

You can change the camera settings by displaying the SETUP menu from the shooting setting menu (👉 P.63) or playback setting menu (👉 P.100).

The SETUP menu enables you to set the items listed in the table below.

Setting	Options [Default Settings]	Refer to
FORMAT [CARD]	_____	P.124
FORMAT [INT. MEM.]	_____	P.125
LCD BRIGHTNESS	_____	P.126
REG. MY SETTINGS	[SETTING1], SETTING2	P.127
STEP ZOOM	ON, [OFF]	P.129
ISO AUTO-HIGH	[AUTO 400], AUTO 800, AUTO1600	P.130
SUB FILE SIZE	1280[1M], 640[VGA], 480, [320[QVGA]]	P.131
AUTO POWER OFF	OFF, [1 MIN.], 5 MIN., 30MIN.	P.132
BEEP SOUND	[ALL], SHUTTER	P.133
VOL. SETTINGS	<input type="checkbox"/> <input type="checkbox"/> <input type="checkbox"/> (OFF), <input checked="" type="checkbox"/> <input type="checkbox"/> <input type="checkbox"/> (Small), [<input checked="" type="checkbox"/> <input checked="" type="checkbox"/> <input type="checkbox"/>] (Medium), <input checked="" type="checkbox"/> <input checked="" type="checkbox"/> <input checked="" type="checkbox"/> (Large)	P.134
LCD CONFIRM.	OFF, [0.5SEC.], 1 SEC., 2 SEC., 3 SEC.	P.135
ADJ BTN. SET.1 ^{*1}	[OFF] ^{*4} , [EXPO.CMP] ^{*1} , [WHT.BAL.] ^{*2} , [ISO] ^{*3} ,	P.136
ADJ BTN. SET.2 ^{*2}	QUALITY, FOCUS, SHARP, AE METERING, CONT	
ADJ BTN. SET.3 ^{*3}	MDE, AUTO BKT, WITH SND	
ADJ BTN. SET.4 ^{*4}		
AF AUX. LIGHT	[ON], OFF	P.137
DIGITAL ZOOM IMG	[NORMAL], AUTO RSZ	P.138
SHTG STGS WARNG.	[ON], OFF	P.140
ENLGE PHOTO ICON	ON, [OFF]	P.141
USB CONNECTION	[MASS STR], ORIGINAL	P.142
SEQUENTIAL NO.	ON, [OFF]	P.144
DATE SETTINGS	_____	P.146
LANGUAGE/言語 [*]	日本語, ENGLISH, DEUTSCH, FRANÇAIS, ITALIANO, ESPAÑOL, 簡体中文, 繁体中文, 한국어	P.147
VIDEO OUT MODE [*]	NTSC, PAL	P.148

* The default setting varies depending on where you purchased the camera.

Using the SETUP Menu

This explains how to make the settings.

Use the ▲▼▶ buttons and MENU/OK button to select and set an item.

1 Press the MENU/OK button.

- The shooting setting menu (or the playback setting menu) appears.

2 Press the ▶ button.

- The SETUP menu appears.

The menu items are provided on five screens.



3 Press the ▲▼ buttons to select the desired item.

- Press the ▼ button at the bottom item to display the next screen.



4 Press the ▶ button.

- The menu item settings are displayed.

5 Press the ▲▼ buttons to select the setting.

6 Press the MENU/OK button, or ◀ button and press the MENU/OK button.



- The SETUP menu disappears and the camera is ready for shooting or playback.
- The SETUP menu may appear depending on the setting. In this case, press the MENU/OK button again to return to the shooting or playback screen.



Note

For some functions, the setting selection method may differ from what is explained here. For detailed operation, see the explanation of each function.



Changing the display

- You can select a screen by the screen number:
 - 1 Press the ◀ button to select a screen number on the left of the screen.
 - 2 Press the ▲▼ buttons to change screens.
 - 3 Press the ▶ button to return to menu item selection.



Preparing the SD Memory Card (FORMAT [CARD])

If the error message [CARD ERROR] is displayed when an SD memory card is loaded into the camera or the card has been used with a computer or other device, you must format the card prior to use with this camera.

Formatting is the process of preparing a card so image data can be written on it.



Caution-----

If you format a card that still has images stored on it, the images will be lost.

To format a card, follow the steps below.

1 Display the SETUP menu.

- For the operating procedure, see P.122.

2 Press the ▼ button to select [FORMAT [CARD]] and press the ► button.

- A screen appears to confirm formatting.



3 Press the ◀▶ buttons to select [YES] and then press the MENU/OK button.

- Formatting starts. When it is done, the display returns to the SETUP menu.
- If no SD memory card is loaded, a message will be displayed. After turning the power off, load an SD memory card and repeat the formatting process again.

4 Press the MENU/OK button.



Protecting your images from being deleted-----

- Move the write-protection switch on the SD memory card to “LOCK” to prevent your still images from being accidentally erased or the card from being formatted.
(☞ P.21)
- If you unlock the card (by returning the switch to its original position), it is once again possible to erase images and format the card.

Formatting the Internal Memory (FORMAT [INT. MEM.])

If the error message [FORMAT INTERNAL MEMORY] is displayed, you must format the internal memory prior to use.



Caution

Formatting the internal memory deletes all of the images recorded in the memory. If you have images in the internal memory that you do not want to delete, copy the images to the SD memory card before formatting the internal memory. (☞ P.109)

To format the internal memory, follow the steps below.

1 Display the SETUP menu.

- For the operating procedure, see P.122.

2 Press the ▼ button to select [FORMAT [INT. MEM.]] and press the ► button.

- A screen appears to confirm formatting.

3 Press the ◀▶ buttons to select [YES] and then press the MENU/OK button.

- Formatting starts. When it is done, the display returns to the SETUP menu.

4 Press the MENU/OK button.

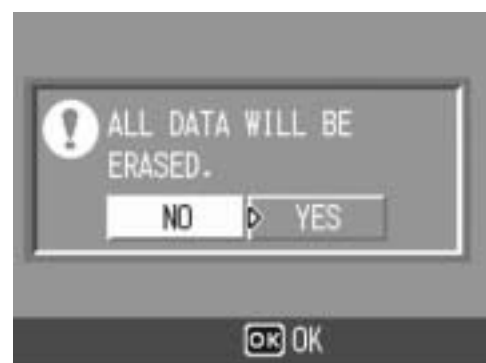

Adjusting the Brightness of the LCD Monitor (LCD BRIGHTNESS)

To adjust the brightness of the LCD monitor, follow the steps below.

1 Display the SETUP menu.

- For the operating procedure, see P.122.

2 Press the ▼ button to select [LCD BRIGHTNESS] and press the ► button.

- The screen for setting the brightness appears.



3 Press the ▲▼ buttons to adjust the brightness.

- Move the slider on the LCD brightness adjustment bar down to make the LCD monitor darker and up to make it brighter. The brightness of the LCD monitor changes as the slider is moved along the bar.



4 When you reach the desired brightness, press the MENU/OK button.

- The display returns to the SETUP menu.

5 Press the MENU/OK button.



Using the DISP. button to adjust the brightness -----

When shooting, press and hold down the DISP. button to maximize the LCD brightness. When the brightness is at the maximum setting, holding the DISP. button down returns the brightness to the level set in [LCD BRIGHTNESS].



Note -----

When the LCD monitor is on and is left for a few seconds, it will turn off to conserve battery power. Operate the camera to turn on again.

Registering Custom Settings (REG. MY SETTINGS)

The My Settings function allows you to easily shoot with your desired settings.

You can register two groups of settings as “My Settings”, and then switch the mode selector to MY (My Settings mode) and select [MY SETTING 1] or [MY SETTING 2] to activate your custom settings.

(☞ P.38)

To register the current camera settings as My Settings, follow the steps below.

1 Change the camera settings to the settings to be registered as My Settings.

2 Display the SETUP menu.

- For the operating procedure, see P.122.

3 Press the ▼ button to select [REG. MY SETTINGS] and press the ► button.

- A confirmation message appears.

4 Select [SETTING1] or [SETTING2] and press the MENU/OK button.

- The current camera settings are registered and the display returns to the SETUP menu.
- If you do not want to register them, press the DISP. button.

5 Press the MENU/OK button.

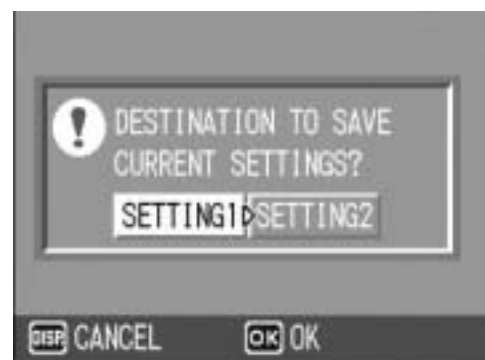
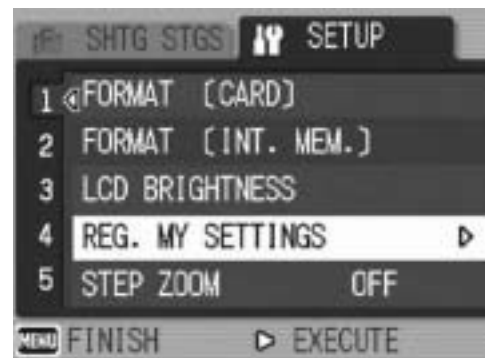

Settings Saved in the My Setting Function

PIC QUALITY/SIZE

FOCUS

Focal distance used in Manual

AE METERING

SHARPNESS

CONT. MODE

COLOR DEPTH

EXPOSURE COMP.

TIME EXPOSURE

IMAGE WITH SOUND

DATE IMPRINT

WHITE BALANCE

ISO SETTING

SLOW SHUTTER LMT

CAMERA SHAKE COR

Zoom position

Macro

Flash

Self-timer

DISP. Mode

ENLGE PHOTO ICON

DIGITAL ZOOM IMG

STEP ZOOM

SUB FILE SIZE

RECORD DUAL SIZE

5

Changing Camera Settings

Changing the Step Zooming Setting (STEP ZOOM)

Step zooming is the setting of the focal length with optical zooming, which can be fixed to any of seven levels (28, 35, 50, 85, 105, 135, 200 mm, equivalent to that on a 35mm camera).

Available Settings

ON (Step zooming on)

OFF (Step zooming off) *Default setting

To set step zooming, follow the steps below.

- 1 Display the SETUP menu.**
 - For the operating procedure, see P.122.
- 2 Press the ▼ button to select [STEP ZOOM] and press the ► button.**
- 3 Press the ▲▼ buttons to select the desired setting.**
- 4 Press the MENU/OK button, or ◀ button and press the MENU/OK button.**



Note

For step zooming in macro mode, the focal length can be fixed to any of seven levels (31, 35, 50, 85, 105, 135, and 200 mm, equivalent to that on a 35mm camera).

Changing the ISO AUTO-HIGH Setting (ISO AUTO-HIGH)

You can change the upper limit of the ISO setting for [AUTO-HI] (Auto high sensitivity setting) (👉 P.90) in [ISO SETTING] on the shooting setting menu.

Available Settings

AUTO 400 *Default setting

AUTO 800

AUTO1600

To change the auto high sensitivity setting, follow the steps below.

1 Display the **SETUP** menu.

- For the operating procedure, see P.122.

2 Press the ▼ button to select [ISO AUTO-HIGH] and press the ► button.

3 Press the ▲▼ buttons to select the desired setting.

4 Press the MENU/OK button, or press the ◀ button and then the MENU/OK button.



Note

Images shot with a higher sensitivity may appear grainy.

Changing the Size for RECORD DUAL SIZE (SUB FILE SIZE)

When shooting a still image with a subfile (P.94), you can select the size of the subfile that is recorded at the same time as the original still image.

Available Settings

1280[1M]

640[VGA]

480

320[QVGA] *Default setting



Caution

No subfile is created when [PIC QUALITY/SIZE] for the original still image is set to [F1280(1M)] or [N1280(1M)] and [SUB FILE SIZE] is set to [1280[1M]].

1

Display the SETUP menu.

- For the operating procedure, see P.94.

2

Press the ▼ button to select [SUB FILE SIZE] and press the ► button.

3

Press the ▲▼ buttons to select the desired setting.

4

Press the MENU/OK button, or press the ◀ button and then the MENU/OK button.



Changing the Auto Power Off Setting (AUTO POWER OFF)

If you do not operate the camera for a set period of time, it shuts off automatically to conserve battery power (Auto Power Off).

By default, auto power off is set to one minute, but you can change this setting.

Available Settings

OFF (Auto Power Off is turned off)

1 MIN. *Default setting

5 MIN.

30MIN.

To change the auto power off setting, follow the steps below.

1 Display the **SETUP** menu.

- For the operating procedure, see P.122.

2 Press the ▼ button to select [AUTO POWER OFF] and press the ► button.

3 Press the ▲▼ buttons to select the desired setting.

4 Press the MENU/OK button, or ◀ button and press the MENU/OK button.



Note

- To continue using the camera after auto power off turned the camera off, press the POWER button to turn the camera on again. You can also press and hold the ► (Playback) button for more than one second to turn on the camera in playback mode.
- Auto power off does not work when the camera is connected to a computer or printer.
- When using interval shooting, the [AUTO POWER OFF] setting is not valid and auto power off does not work.

Changing the Beep Sound Setting (BEEP SOUND)

During operation, the camera generates four types of sounds: start sound, shutter release sound, focus sound, and beep sound.

- Start sound : Sound when the camera is turned on.
- Shutter release sound : Sound when the shutter release button is pressed.
- Focus sound : Sound when the shutter release button is half-pressed and the camera focuses on the subject.
- Beep sound : Error sound indicating an operation that cannot be performed.

Available Settings

ALL (All sounds on) *Default setting

SHUTTER (Shutter release sound and beep sound only)

To change the beep sound settings, follow the steps below.

1 Display the **SETUP** menu.

- For the operating procedure, see P.122.

2 Press the ▼ button to select **[BEEP SOUND]** and press the ► button.

3 Press the ▲▼ buttons to select the desired setting.

4 Press the **MENU/OK** button, or ◀ button and press the **MENU/OK** button.



Changing the Beep Sound Volume (VOL. SETTINGS)

The beep sound volume can be changed.

Available Settings

- (Mute)
- (Small)
- (Medium) *Default setting
- (Large)

To change the beep sound volume, follow the steps below.

1 Display the **SETUP** menu.

- For the operating procedure, see P.122.

2 Press the **▼** button to select **[VOL. SETTINGS]** and press the **▶** button.

3 Press the **▲▼** buttons to select the desired setting.

4 Press the **MENU/OK** button, or **◀** button and press the **MENU/OK** button.



Changing Image Confirmation Time (LCD CONFIRM.)

Immediately after you press the shutter release button, the still image taken is displayed on the screen for a moment so you can check it. By default, the image confirmation time is set to 0.5 second, but this can be changed.

Available Settings

OFF (Image not displayed for confirmation)

0.5SEC. *Default setting

1 SEC.

2 SEC.

3 SEC.

To change the image confirmation time, follow the steps below.

1 Display the **SETUP** menu.

- For the operating procedure, see P.122.

2 Press the **▼** button to select [LCD CONFIRM.] and press the **▶** button.

3 Press the **▲▼** buttons to select the desired setting.

4 Press the **MENU/OK** button, or **◀** button and press the **MENU/OK** button.

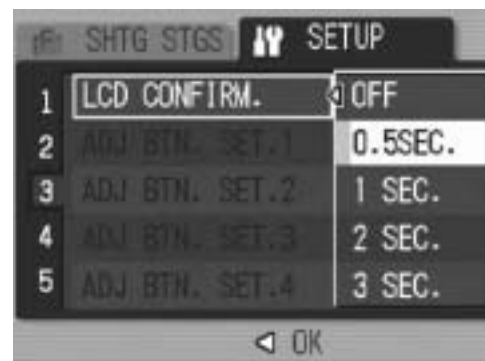

Caution

When [LCD CONFIRM.] is set to 0.5 seconds, symbols such as the zoom bar may remain on the monitor while the image is displayed.

Assigning Functions to the ADJ. Button (ADJ. BTN. SET.)

When functions are assigned to the ADJ. button, you can display various shooting setting screens with fewer button operations and without displaying the shooting setting menu.

You can use [ADJ BTN. SET.1] to [ADJ BTN. SET.4] to assign camera functions that can be activated by pressing the ADJ. button.

Available Settings		Refer to
OFF	*Default setting for [ADJ BTN. SET.4]	-
EXPO.CMP	*Default setting for [ADJ BTN. SET.1]	P.86
WHT.BAL.	*Default setting for [ADJ BTN. SET.2]	P.87
ISO	*Default setting for [ADJ BTN. SET.3]	P.90
QUALITY (PIC QUALITY/SIZE)		P.66
FOCUS		P.68
SHARPNESS		P.72
AE METERING		P.71
CONT. MODE		P.73
AUTO BRACKET		P.78
WITH SND (IMAGE WITH SOUND)		P.84

To assign a function to [ADJ BTN. SET.1] to [ADJ BTN. SET.4], follow the steps below.

- 1** Display the **SETUP** menu.
 - For the operating procedure, see P.122.
- 2** Press the ▼ button to select [ADJ BTN. SET.1], [ADJ BTN. SET.2], [ADJ BTN. SET.3], or [ADJ BTN. SET.4], and then press the ► button.
- 3** Press the ▲▼ buttons to select the desired setting.
- 4** Press the MENU/OK button, or press the ◀ button and then the MENU/OK button.



Note

For information on how to use the ADJ. button, see P.60.

Changing the AF Auxiliary Light Setting (AF AUX. LIGHT)

You can set whether to use the AF auxiliary light when shooting with auto focus.

When [AF AUX. LIGHT] is set to [ON], the AF auxiliary light lights as required during shooting, and the auto focus distance is measured.

To change the AF auxiliary light setting, follow the steps below.

1 Display the **SETUP** menu.

- For the operating procedure, see P.122.

2 Press the ▼ button to select [AF AUX. LIGHT] and press the ► button.

3 Press the ▲▼ buttons to select the desired setting.

4 Press the MENU/OK button, or press the ◀ button and then the MENU/OK button.



Note

- When [AF AUX. LIGHT] is set to [ON], the AF auxiliary light lights when shooting in dark surroundings and when it is difficult for the camera to measure the auto focus distance.
- When you full-press the shutter release button with [AF AUX. LIGHT] set to [ON], the AF auxiliary light may not light even when shooting in dark surroundings.

Using the Auto Resize Zoom (DIGITAL ZOOM IMG)

This function allows you to crop and record a shot image. Conventional digital zoom enlarges a portion of an image to a set magnification. However, auto resize zoom saves the cropped portion of the image so the image quality is not be decreased. The image recording size changes depending on the auto resize zoom magnification.

Auto resize zoom is available only when [PIC QUALITY/SIZE] is set to 3072 × 2304. (☞ P.66)

Available Settings

Available Settings	Description
NORMAL	Records the image at the image size set with [PIC QUALITY/SIZE].
AUTO RSZ (Auto resize)	Automatically resizes and then records the image.



Note

The digital zoom is enabled when [PIC QUALITY/SIZE] is set to a size other than 3072 × 2304.

5

Zoom Magnification and Recorded Image Size

Zoom Magnification	7.1 times	7.1 × 1.2 times	7.1 × 1.5 times	7.1 × 2.4 times	7.1 × 4.8 times
Image Size	3072 × 2304 (7M)	2592 × 1944 (5M)	2048 × 1536 (3M)	1280 × 960 (1M)	640 × 480 (VGA)

1

Display the **SETUP** menu.

- For the operating procedure, see P.122.

2

Press the ▼ button to select [DIGITAL ZOOM IMG] and press the ► button.

3

Press the ▲▼ buttons to select [AUTO RSZ].

4

Press the MENU/OK button, or ◀ button and press the MENU/OK button.

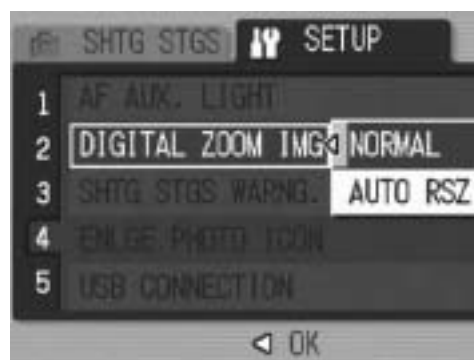

5 Turn and hold the zoom lever toward [▲] (Telephoto) until the maximum magnification is reached on the zoom bar, then momentarily release the zoom lever, and then turn the zoom lever again toward [▲] (Telephoto).



- Turn the zoom lever again towards [▲] (Telephoto) to change the image size one factor and record the image.
- The size at which the image is recorded is displayed above the zoom bar.



Caution-----

This function is not available when shooting with CONT. or when scene mode is set to [SKEW COR MODE]. If [AUTO RSZ] is set in these situations, the digital zoom is activated instead.

Displaying a Settings Change Warning (SHTG STGS WARNG.)

If the initial settings are changed for the following functions, you can set the camera to have the icon of that function blink and to display a warning message about the function with the changed setting for a few seconds when the camera is turned on.

White balance, Focus, ISO setting, Exposure compensation, Time exposure

If you operate a camera button while an icon is blinking, the icon stops blinking and lights steadily. If you operate a camera button while the warning message is displayed, the message disappears.

Available Settings

ON (Enable warnings) *Default setting

OFF (Disable warnings)

To set the settings change warning, follow the steps below.

1 Display the SETUP menu.

- For the operating procedure, see P.122.

2 Press the ▼ button to select [SHTG STGS WARNG.] and press the ► button.

3 Press the ▲▼ buttons to select the desired setting.

4 Press the MENU/OK button, or ◀ button and press the MENU/OK button.



Enlarging Icon Display (ENLGE PHOTO ICON)

The following icons are enlarged in normal symbol display (☞ P.55).

Flash, Macro Shooting, Self-timer, White balance, Focus, Exposure compensation, ISO setting

When the icons are enlarged, the following items are not displayed:

Zoom bar/Focus bar, Date imprint, Sharpness, Color depth

To enlarge the icons on the screen, follow the steps below.

1 Display the SETUP menu.

- For the operating procedure, see P.122.

2 Press the ▼ button to select [ENLGE PHOTO ICON] and press the ► button.

3 Press the ▲▼ buttons to select the desired setting.

4 Press the MENU/OK button, or ◀ button and press the MENU/OK button.



Changing the USB Setting (USB CONNECTION)

To transfer images to your computer using software, change the [USB CONNECTION] setting depending on the software. By setting [USB CONNECTION] to [MASS STR] on the SETUP menu, you can view files in the camera and transfer files from the camera to your computer using the USB cable without installing the supplied software or USB driver.

Software used for transfer	[USB CONNECTION] setting
Instead of using software, the computer recognizes the SD memory card or internal memory of the camera as a drive.	MASS STR* *Default setting
RICOH Gate La	MASS STR /ORIGINAL* *Default setting (Either setting can be used.)
Auto Document Link	ORIGINAL
Caplio Transfer	ORIGINAL

* For Windows 98SE, set [USB CONNECTION] to [ORIGINAL].
When set to [ORIGINAL], the maximum size for a transferable SDHC memory card is 4 GB.



Caution-----

- Images in the camera cannot be deleted when [USB CONNECTION] is set to [MASS STR].
- Do not format the SD memory card or internal memory from your computer when connected via mass storage mode. Be sure to format using the camera.
- Be sure to stop the connection before removing the USB cable when connected in mass storage mode.
- Files will not be properly transferred if the USB cable is removed while transferring images from an SD memory card inserted in the camera to your computer before stopping the connection.

Also, transferring to the internal memory is not available with this camera.

To change the USB setting, follow the steps below.

1 Display the SETUP menu.

- For the operating procedure, see P.122.

2 Press the ▼ button to select [USB CONNECTION] and press the ► button.

3 Press the ▲▼ buttons to select the desired setting.

4 Press the MENU/OK button, or ◀ button and press the MENU/OK button.



Note -----

For how to download images from the camera to a computer using the USB cable, see P.160-165.

Changing File Name Settings (SEQUENTIAL NO.)

When you shoot a still image, it is stored on an SD memory card or in the internal memory with a consecutively numbered file name that is automatically assigned.

When you switch SD memory cards, you can set your camera to continue consecutive numbering from the previously loaded card.

Available Settings	
ON (Continue numbering)	File names are automatically assigned to still images you take, in the format of "R" followed by seven digits, from R0010001.jpg to R9999999.jpg. With this setting, file numbering is continued from one card to the next.
OFF (Do not continue numbering) *Default setting	File numbering is assigned, from RIMG0001.jpg to RIMG9999.jpg, for each SD memory card. When file name RIMG9999 is reached, no more data can be recorded to that card.

To change the file name setting, follow the steps below.

1 Display the **SETUP** menu.

- For the operating procedure, see P.122.

2 Press the **▼** button to select **[SEQUENTIAL NO.]** and press the **▶** button.

3 Press the **▲▼** buttons to select the desired setting.

4 Press the **MENU/OK** button, or **◀** button and press the **MENU/OK** button.





Note

- When data is recorded to the internal memory, files are assigned consecutively numbered file names, just as if [SEQUENTIAL NO.] is set to [OFF].
- When images are transferred to a computer using RICOH Gate La (👉 P.163), the file being transferred is renamed and saved. The file is saved with the name “RIMG****.jpg” (where **** indicates a number) even if [SEQUENTIAL NO.] is set to [ON].
- When RIMG9999 is reached, no more files can be saved. In this case, move image data from the SD memory card to the memory of the computer or a storage medium, and then format the SD memory card.

Setting the Date and Time (DATE SETTINGS)

You can shoot still images with the time or date stamped onto the picture.

The date/time setting on the SETUP menu is explained here.

1 Display the SETUP menu.

- For the operating procedure, see P.122.

2 Press the ▼ button to select [DATE SETTINGS] and press the ► button.



3 Press the ▲▼◀▶ buttons to set the year, month, date and time.

- You can press and hold down the ▲▼ buttons to quickly raise or lower the setting.
- Press the ◀▶ buttons to move to the next item.

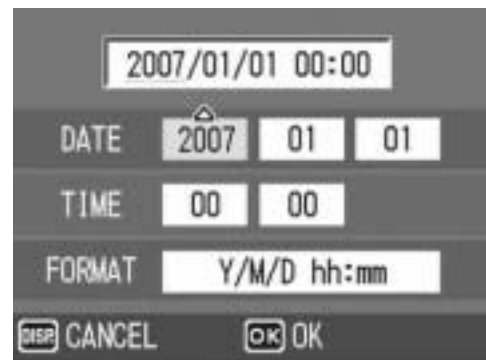

4 In [FORMAT], choose the date and time format.

5 Check the information on the screen and then press the MENU/OK button.

- Once you have set the date and time, the display returns to the SETUP menu.

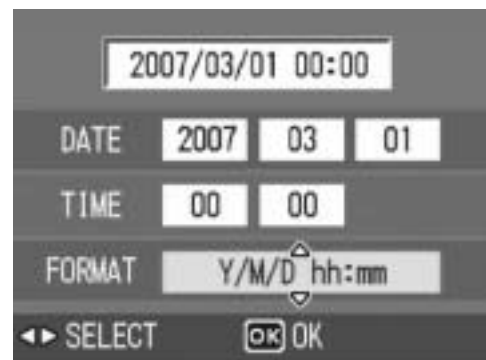

6 Press the MENU/OK button.



Note

- If the battery is removed for more than one week, the date and time settings will be lost. These settings must be made again.
- To retain the date and time settings, load a battery with adequate remaining power for more than two hours.

Changing the Display Language (LANGUAGE/言語)

You can change the language displayed on the screen. The default setting varies depending on where you purchased the camera.

Available Settings

日本語 (Japanese)

ENGLISH

DEUTSCH (German)

FRANÇAIS (French)

ITALIANO (Italian)

ESPAÑOL (Spanish)

簡体中文 (Simplified Chinese)

繁体中文 (Traditional Chinese)

한국어 (Korean)

To change the display language, follow the steps below.

1 Display the **SETUP** menu.

- For the operating procedure, see P.122.

2 Press the ▼ button to select [LANGUAGE/言語] and press the ► button.

- The language selection screen appears.

3 Press the ▲▼◀▶ buttons to select the desired setting.

4 Press the MENU/OK button.

- Once you have set the language, the display returns to the SETUP menu.

5 Press the MENU/OK button.



Changing the Playback Method for Viewing on TV (VIDEO OUT MODE)

You can view your still images and movies on a television screen by connecting your camera to a television with the AV cable that came with your camera. (👉 P.113)

Your camera is set to NTSC video format (used in North America and other countries/regions) for use with television equipment and other audiovisual equipment. If the equipment you want to connect to uses PAL format (used in Europe and elsewhere), then switch your camera to PAL format before connecting.

The default setting varies depending on where you purchased the camera.

Available Settings

NTSC

PAL

To change the video format, follow the steps below.

5

Changing Camera Settings

1 Display the **SETUP** menu.

- For the operating procedure, see P.122.

2 Press the ▼ button to select **[VIDEO OUT MODE]** and press the ► button.

3 Press the ▲▼ buttons to select the desired setting.

4 Press the **MENU/OK** or ◀ button.

- Once you have set the video format, the display returns to the **SETUP** menu.

5 Press the **MENU/OK** button.



6 Downloading Images to Your Computer

The screen images shown here may differ from the images displayed on your computer depending on your computer OS.

For Windows

Refer to P.166 for Macintosh.

You need to install software for transferring images to your computer before you can download images from the camera. Software installation is necessary for automatic image downloading from the camera to your computer.



Caution

Be sure to install the software before you connect the camera to your computer. (☞ P.153)

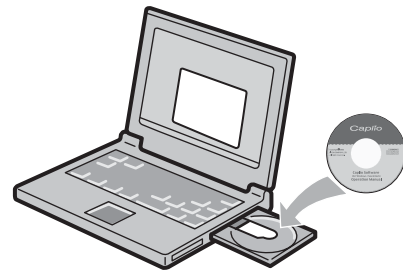

Note

- When [MASS STR] is selected for [USB CONNECTION] of the camera's SETUP menu, you can view the files in the camera without installing the supplied software or USB driver. (☞ P.161) At the time of purchase, [MASS STR] is selected.
- For how to download images from the camera to your computer, see the "Software User Guide" available from the Caplio Software CD-ROM. For how to display the "Software User Guide", see P.151.

Using the Caplio Software CD-ROM

Once you insert the Caplio Software CD-ROM in the CD-ROM drive, the installer screen appears automatically.



Item Name	Description	Refer to
Installing the Software	Use this button to install software required for handling the camera and images.	P.153
Installing DeskTopBinder Lite	Use this button to install software required for handling the camera and images.	P.155
Browse User's Manual (Software Version)	Click this to display the "Software User Guide" (PDF).	P.151
Browse CD-ROM Content	Click this to display the list of files contained on the CD-ROM.	P.151

When [Installing the software] is clicked: (👉 P.153)

The following software is installed:

Software	Windows		Description
	XP	98	
RICOH Gate La	○	○	Downloads images collectively.
Irodio Photo & Video Studio	○	○	Shot images can be displayed or edited and video CDs can be created.
USB Driver	-	○	Used to connect the camera to your computer when [USB CONNECTION] is set to [ORIGINAL].
WIA Driver	○	-	Used to connect the camera to your computer when [USB CONNECTION] is set to [ORIGINAL].

XP: Windows XP

98: Windows 98SE/Me/2000



Note

The camera is provided with Irodio Photo & Video Studio software that allows you to display and edit images from your computer. For how to use Irodio Photo & Video Studio, see the displayed "Help".

For the latest information about Irodio Photo & Video Studio, access the Web page of Pixela Co., Ltd. (<http://www.pixela.co.jp/oem/ricoh/e/index.html>).

When [Installing DeskTopBinder Lite] is clicked: (👉 P.155)

The following software is installed:

Software	Windows		Description
	XP	98	
DeskTopBinder Lite	○	○	Software used to manage business documents. Images in the camera can be downloaded to DeskTopBinder Lite using the Auto Document Link that monitors document updating.
USB Driver	○	○	Used to connect the camera to the computer.
WIA Driver	○	-	Used to download images.

XP: Windows XP

98: Windows 98SE/Me/2000



Caution-----

DeskTopBinder Lite is compatible with Windows 98SE but not Windows 98.



Note-----

- For details about the DeskTopBinder Lite, refer to the Introduction Guide, Setup Guide, Auto Document Link Guide, and Help supplied with the DeskTopBinder Lite.
- For details about the Auto Document Link, refer to the Auto Document Link Guide.

When [Browse User's Manual (Software Version)] is clicked:

The “Software User Guide” (PDF file) on the Caplio Software CD-ROM is displayed on your computer screen.

If you have Acrobat Reader installed on your computer, simply click [Browse User's Manual (Software Version)]. Acrobat Reader must be installed to view the PDF file. (👉 P.157)

When [Browse CD-ROM Content] is clicked:

You can check folders and files on the CD-ROM. The CD-ROM contains not only the software installed by clicking [Installing the software] but also Acrobat Reader software. This software product runs on Windows.

For the installation of Acrobat Reader, see P.157.



Note-----

- For details about Acrobat Reader, see Help for Acrobat Reader.
- To install Irodio Photo & Video Studio alone, double-click “Irodio Photo & Video Studio.exe” in the Irodio Photo & Video Studio folder.
- When using Windows 98SE, the USB setting must be changed to [ORIGINAL]. (👉 P.142)

System Requirements for Using Caplio Software CD-ROM

The following environments are necessary for using Caplio Software CD-ROM.

Please check your computer, or the computer's user manual.

Operating Systems Supported	Windows 98 Second Edition Windows 2000 Professional Windows Me Windows XP Home Edition/Professional
CPU	Pentium III: 500 MHz or faster
Memory	Windows 98SE: 256 MB or more Windows 2000: 256 MB or more Windows Me: 256 MB or more Windows XP: 256 MB or more
Hard drive space required for installation	Windows 98SE: 160 MB or more Windows 2000: 160 MB or more Windows Me: 160 MB or more Windows XP: 160 MB or more
Display Resolution	1024 × 768 pixels or greater
Display Colors	65,000 colors or greater
CD-ROM Drive	A CD-ROM drive compatible with the above-mentioned computer
USB Port	A USB port compatible with the above-mentioned computer



Caution-----

- If your computer has an upgraded OS, the USB function may not work normally, so it cannot be supported.
- The provided software may not operate properly if changes are made to the operating system, such as with patches and service package releases.
- The camera does not support connection to a USB port added by using an extension function (PCI bus or other).
- If used in conjunction with a hub or other USB devices, the software may not work properly.
- When dealing with movies and other large files, a larger memory environment is recommended.

Installing the Software Required for Handling the Camera and Images

Install the required software on your computer before connecting the camera.



Caution

- Do not install the software when the camera is connected to your computer with a USB cable.
- If you happened to connect your camera to the computer (resulting in the [Add New Hardware Wizard] screen appearing on your computer screen), simply click [Cancel], and after disconnecting your camera, install the software on your computer.
- If software is already installed from a Caplio Software CD-ROM from a previous model, a message stating that the old software must be uninstalled before installing the new one is displayed. Follow the message instructions and uninstall the old software before installing the new software. Functions of the old model can still be used as before. If DU-10 is installed, it is replaced by Caplio Viewer (an upgraded version of DU-10). If the old software is uninstalled before the message is displayed, Caplio Viewer is not installed even if the new software is installed. (For how to uninstall the software, see P.158.)
- For Windows XP or Windows 2000, administrator privileges are required to install the software.
- Ricoh Gate La is not network-compatible. Use as a stand-alone application.

Here is an example of the Windows XP screen.

1 Start your computer and insert the Caplio Software CD-ROM in the CD-ROM drive.

- The installer screen appears automatically.

2 Click [Installing the software].

- After a while, the [Choose Setup Language] screen appears.

3 Confirm the language, and then click [OK].

- The [Welcome to the InstallShield Wizard for Caplio Software] screen appears.



4 Click [Next].

- The [Choose Destination Location] screen appears.

5 Confirm where you want to install and then click [Next].

- The [Select Program Folder] screen appears.

6 Confirm the destination location and then click [Next].

- The Irodio Photo & Video Studio installer starts.
Install Irodio Photo & Video Studio following the messages displayed on the screen.

- When installation of Irodio Photo & Video Studio is completed, a dialog box appears, indicating that all software applications have been installed.

7 Click [Finish].

8 Restart your computer.



Note

You can remove (uninstall) the software. (☞ P.158)



Installing the DeskTopBinder Lite

DeskTopBinder Lite is used for managing business documents. As well as still images captured with a digital camera, you can manage a variety of documents, including documents input by scanner, documents created with various applications and image files. You can also store files with different formats in a single document. Images downloaded from the camera can be saved to DeskTopBinder Lite using the Auto Document Link for monitoring document updating.

Note -----
 For how to use DeskTopBinder Lite, refer to the Introduction Guide, the Setup Guide, and the DeskTopBinder Lite - Auto Document Link Guide that are installed with DeskTopBinder Lite.

- Caution**-----
- If you happened to connect your camera to the computer (resulting in the [Add New Hardware Wizard] screen appearing on your computer screen), simply click [Cancel], and after disconnecting your camera, install the software on your computer.
 - For Windows XP or Windows 2000, administrator privileges are required to install the software.
 - To download images from the camera using the Auto Document Link of DeskTopBinder Lite, install the Caplio Software before installing DeskTopBinder Lite. (P.153) The driver included in the Caplio Software is required to use the Auto Document Link.
 - If [Caplio Digital Camera] is set as the monitoring destination of the Auto Document Link, select [ORIGINAL] for [USB CONNECTION] on the camera menu. (P.142)

Here is an example of the Windows XP screen.

1 Start your computer and insert the Caplio Software CD-ROM in the CD-ROM drive.

- The installer screen appears automatically.



2 Click [Installing DeskTopBinder Lite].

- After a few moments, the [Welcome to the InstallShield Wizard for Caplio Software S] screen appears.

3 Click [Next].

- After a few moments, the [Choose Destination Location] screen appears.

4 Confirm where you want to install and then click [Next].

- The [Select Program Folder] screen appears.



5 Confirm the destination location and then click [Next].

6 Click [OK].

7 Click [DeskTopBinder Lite].

- The DeskTopBinder Lite installer starts.
- Install DeskTopBinder Lite following the messages displayed on the screen.
- When the screen where you verify digital ID is displayed, click [OK].



Caution-----

- DeskTopBinder Lite cannot coexist with a different version of DeskTopBinder Lite, DeskTopBinder Professional, or Job Binding. Before installing DeskTopBinder Lite, uninstall these applications. The data used in the previous application can be saved and inherited by DeskTopBinder Lite. However, when the previous application is DeskTopBinder Professional, some functions will no longer be available.
- When capturing images from the camera using the Auto Document Link of the DeskTopBinder Lite, deselect the [Saves automatically when connected to USB] check box in the [Option settings] dialog box displayed by selecting [Option settings] on the [RICOH Gate La Settings] menu. (Refer to the “Software User Guide”.) Before capturing images from the camera, set the date and time using the [DATE SETTINGS] option of the camera. (👉 P.146)
- If you turned the camera off and then on again while connected to the computer with DeskTopBinder Lite open, reboot the computer with the camera connected.

Installing Other Software on Your Computer



Caution-----

- Do not install the software when the camera is connected to your computer with a USB cable.
- For Windows XP or Windows 2000, administrator privileges are required to install the software.

Acrobat Reader

Acrobat Reader is required to display the operation manual (PDF file).

If the computer is running under Windows, Acrobat Reader can be installed. Acrobat Reader need not be installed if already installed on your computer.

1 Start your computer, and insert the included Caplio Software CD-ROM into the CD-ROM drive.

- The installer screen appears automatically.

2 Click [Browse CD-ROM Content].

- The files on the CD-ROM are listed.

3 Double-click the [Acrobat] folder.

4 Double-click the [English] folder.

5 Double-click [ar500enu] (ar500enu.exe).

6 Install Acrobat Reader by following the messages displayed.

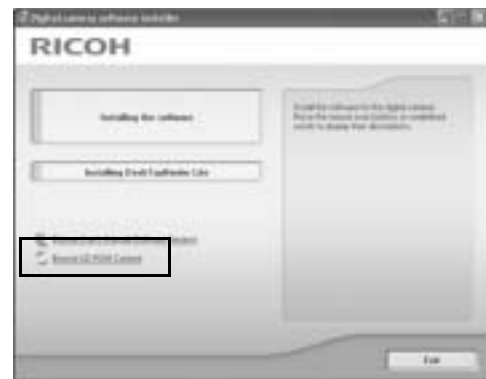

Uninstalling the Software



Caution-----

- For Windows 2000/XP, administrator privileges are required to uninstall the software.
- If any other program is active or unsaved data remains, save the data and terminate the program before uninstalling.
- If you install both Irodio Photo & Video Studio and the DeskTopBinder Lite and then uninstall either one, camera connection to the computer may fail. In this case, uninstall both [Caplio Software] and [Caplio Software S] and then install only the required one.

Caplio Software

- 1** Click [Start] on the Windows task bar.
- 2** Select [Settings]-[Control Panel] ([Control Panel] for XP).
- 3** Double-click the [Add/Remove Programs] icon (or the [Add or Remove Programs] icon in Windows XP).
- 4** Select [Caplio Software] (select [Caplio Software S] if you have installed the DeskTopBinder Lite), and then click the [Change/Remove] button.
- 5** Confirm file deletion and click [OK].
 - The [Shared File Detected] dialog box appears.
- 6** Select the [Don't display this message again.] check box, and then click [Yes].
 - The uninstallation process begins. When it is finished, close the displayed window.

Irodio Photo & Video Studio

- 1** Click [Start] on the Windows task bar.
- 2** Select [Settings]-[Control Panel] ([Control Panel] for XP).
- 3** Double-click the [Add/Remove Programs] icon (or the [Add or Remove Programs] icon in Windows XP).
- 4** Select [Irodio Photo & Video Studio] and then click [Change/Remove].
- 5** Confirm file deletion and click [OK].
 - The uninstallation process begins. When it is finished, close the displayed window.
- 6** Restart your computer.

Downloading Images to Your Computer

After installing the software on your computer, connect your camera to the computer.

Depending on the software you are using, change the [USB CONNECTION] setting on the SETUP menu of the camera.

(👉 P.142)

1 Make sure the camera power is off.

2 Connect the USB cable to the USB port of your computer.

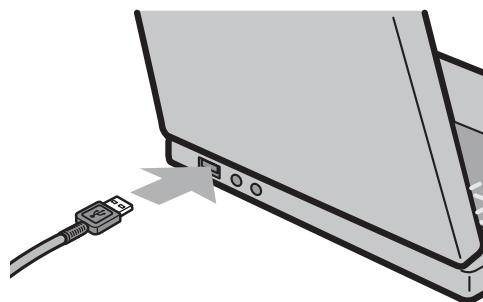

3 Connect the USB cable to the USB terminal of your camera.

- Your camera turns on and the computer automatically reads the necessary files.

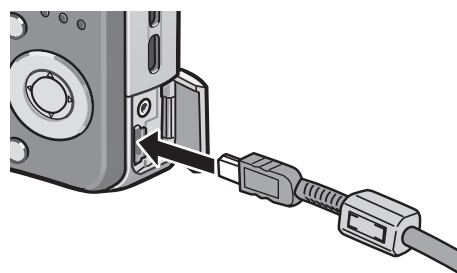

4 RICOH Gate La starts and image transfer begins automatically.

5 When image transfer is completed, disconnect the camera and the computer. (👉 P.165)

Note -----

For how to use RICOH Gate La, refer to the "Software User Guide" (PDF file) contained in the provided CD-ROM. (👉 P.150)

Downloading Images Without Using the Caplio Software

You can download images from the camera to a computer without having to use software.

- 1** Change [USB CONNECTION] to [MASS STR] on the SETUP menu. (👉 P.142)
- 2** Make sure that the camera power is off.
- 3** Connect the accessory USB cable to a USB port of your computer.
- 4** Connect the USB cable to the USB terminal of your camera.



Example of the display in Windows XP

- Your camera turns on.
- Your computer automatically reads a file necessary for recognizing the camera as a drive.
- After this preparation, the camera is displayed as a drive at [My Computer] (Windows) or Desktop (Macintosh).

- 5** From the displayed drive, copy a file to the desired location.

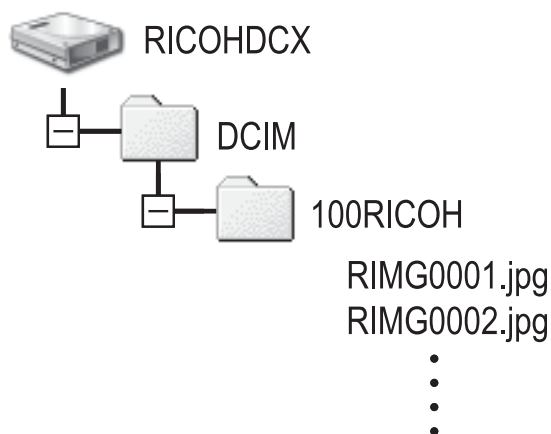

Example of the display in Windows XP



Caution-----

- Mass storage mode is not available on this camera if you are using Windows 98SE. Set to [ORIGINAL]. (👉 P.142)
- Do not turn off the camera or disconnect the USB cable during image transfer.
- If a file with the same name already exists at the destination, it is overwritten. If you do not want the file to be overwritten, rename the file or transfer data to another folder.



Note -----

When an SD memory card is loaded, its files are displayed. Otherwise, files in the internal memory are displayed.



Downloading Images from an SD Memory Card -----

It is possible to download images from an SD memory card to the computer via a PC card slot or card reader. Depending on the type of PC card slot or card reader, a memory card adapter may be required when using an SD memory card. If the SD memory card can be used in the PC card slot, no memory card adapter is required.

- Images are stored in an SD memory card in the hierarchy shown below.

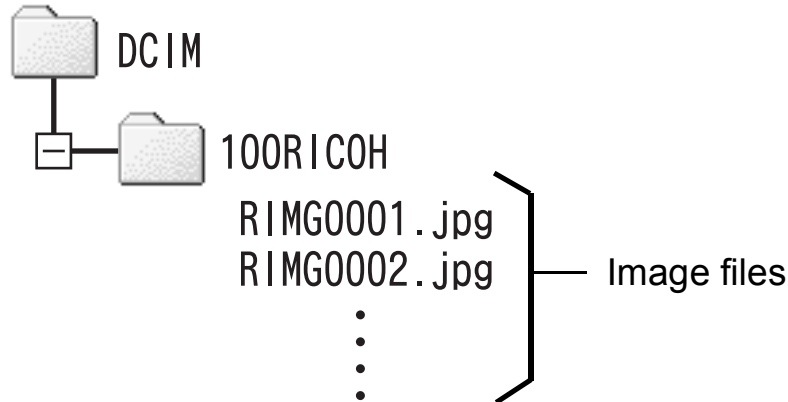

Example of the display in Windows XP

Card Reader

This is a device connected to a computer to read the contents of cards. In addition to the memory card adapter-type, there are card readers compatible with various types of cards, into which you can directly load an SD memory card.

Use a card reader that is compatible with your computer's operating system and the size of the SD memory card.

Using the Original Driver to Download Images

Connecting the Camera to the Computer for the First Time

The first time you connect your camera to the computer using a USB cable, the [Found New Hardware Wizard] screen appears. (Does not appear on Macintosh.)

Here is an example of the Windows XP screen.

1 Select [Install the software automatically (Recommended)].

2 Insert the Caplio Software CD-ROM into the CD-ROM drive on your computer.

- Installation of the WIA driver automatically starts. If the CD-ROM is already on your computer when the [Found New Hardware Wizard] screen is displayed, simply click [Next] to start installation.



3 If the subsequent screen is displayed, click the [Next] button.

- This product has been sufficiently tested at our company and has been confirmed to function correctly.



Note

By default, the WIA driver is installed in the following location:
Specify the folder if the CD-ROM is not available.

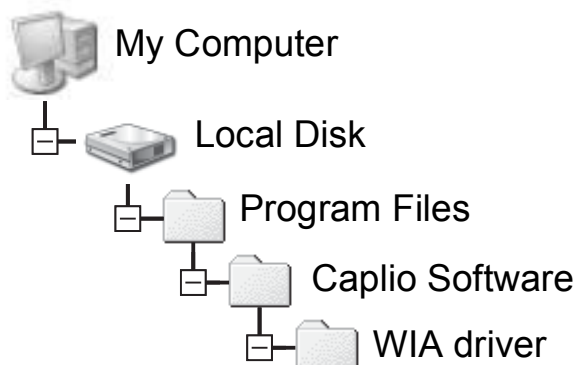

4 Select [RICOH Gate La], check [Always use this program for this action] check box, and then click [OK].

- To load images from the camera with assistance from the Windows XP “Scanner and Camera Wizard”, select [Microsoft Scanner and Camera Wizard].
- Leaving the [Always use this program for this action] check box unchecked causes the [Caplio R6] screen to be displayed each time you transfer images from the camera, thereby allowing you to choose whether to use [RICOH Gate La] or the [Microsoft Scanner and Camera Wizard] for image transfers.
- If your PC is installed with Windows XP Service Pack 2 and a warning message is displayed, see P.174.

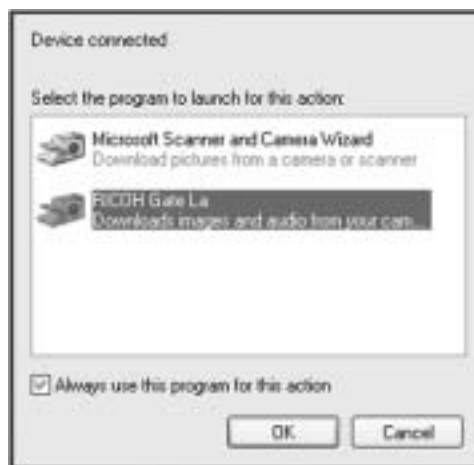

Note -----

- If the computer does not recognize the camera, uninstall the software (☞ P.158) and install it again.
- When downloading images from your camera, load a battery with adequate remaining power in the camera.
- When transferring images to a computer using RICOH Gate La, the file being transferred is renamed and saved.

Disconnecting the Camera from Your Computer

If images are downloaded using RICOH Gate La or the [Scanner and Camera Wizard], turn the camera off after downloading images and disconnect the USB cable.

Perform the following operations when disconnecting the camera from your computer. (The display is an example of Windows XP. The terms are different for other operating systems but the operations are the same.)

- 1** Double-click the [Safely Remove Hardware] icon at the right end of the task bar. 
- 2** Select [USB Mass Storage Device] and click [Stop].
- 3** Check that [USB Mass Storage Device] is selected and click [OK].
- 4** Click [Close].
- 5** Disconnect the USB cable.



Note

- If the USB cable is disconnected without disabling the connection, the Unsafe Removal of Device screen may be displayed.
- Be sure to stop the connection before removing the USB cable when connected in mass storage mode.
- Files will not be properly transferred if the USB cable is removed while transferring images from an SD memory card inserted in the camera to your computer before stopping the connection.

For Macintosh

Refer to P.149 for Windows.

This camera supports the following Macintosh operating systems.

- Mac OS 9.0 to 9.2.2
- Mac OS X 10.1.2 to 10.4.8

Downloading Images to Your Computer



Caution

This function is not available on this camera if you are using Mac OS 8.6.

- 1** Set **[USB CONNECTION]** to **[MASS STR]** on the **SETUP** menu.
- 2** Make sure that the camera power is off.
- 3** Connect the accessory USB cable to a USB port of your computer.

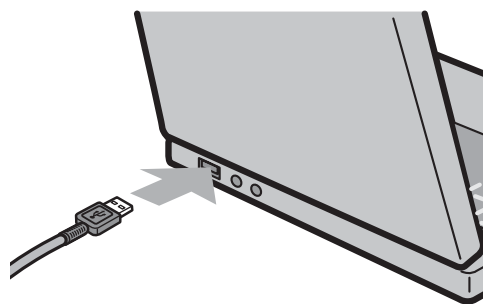

- 4** Connect the USB cable to the USB terminal of your camera.

- Your camera turns on.
- Your computer automatically reads the file necessary for recognizing the camera as a drive.
- After this preparation, the camera is displayed as a drive on the Desktop.

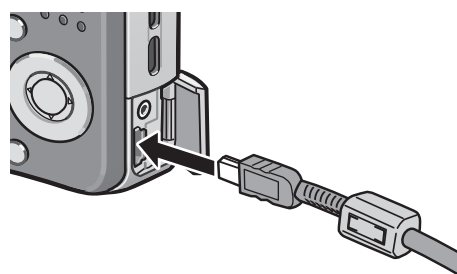

5 From the displayed drive, copy a file to the desired location.

- The figure below shows the folder configuration in the drive.
- When the contents of the internal memory are displayed, the drive name is [RICOHDCI].

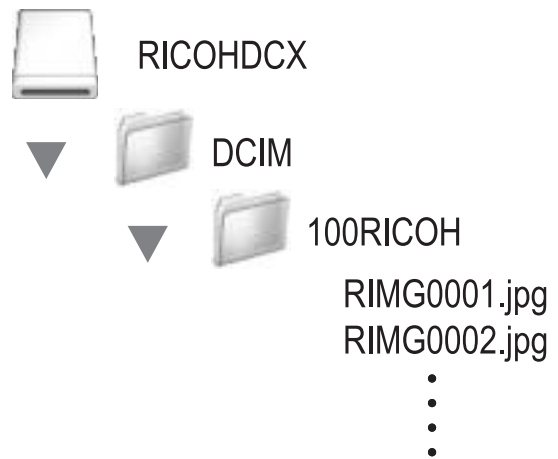

Disconnecting the Camera from Your Computer

1 Drag and drop the displayed drive or the volume icon to the “Trash”.

- If a screen appears prompting you to enter the administrator’s password, enter the password.

2 Disconnect the USB cable.



Note

- You can also click [Eject] on the [Special] menu in Mac OS 9 or the [File] menu in Mac OS X to cancel the connection.
- If the USB cable is disconnected without disabling the connection, the Unsafe Removal of Device screen may be displayed.
- Be sure to stop the connection before removing the USB cable when connected in mass storage mode.
- Files will not be properly transferred if the USB cable is removed while transferring images from an SD memory card inserted in the camera to your computer before stopping the connection.

Troubleshooting

Error Messages

If an error message is displayed on the screen, take the corresponding action.



Error Message	Cause and Action	Refer to
INSERT CARD	No card is loaded. Insert a card.	P.24
SET DATE.	The date is not set. Set the date.	P.146
FILE NUMBER OVER LIMIT	The file number limit has been exceeded. Use another card.	P.144
UNMATCHED FILE	The camera cannot display this file. Check the file contents on your computer, and then delete the file.	-
INSUFFICIENT MEMORY. CONTINUE?	Because there is not sufficient capacity on the card, all the files cannot be copied. Use another card.	P.21
PROTECTED	You are trying to delete a protected file.	P.102
CARD IS WRITE-PROTECTED.	The card is "Locked (write-protected)". Unlock the card.	P.21
PRINT SETTINGS CANNOT BE SET FOR THIS FILE.	This file (movie or other file) cannot be selected for printing.	-
INSUFFICIENT MEMORY	Files cannot be stored. Make sure there is enough free space or delete unwanted files.	P.51 P.124 P.125
	The image print number limit has been exceeded. Select an image and set the number to 0.	-
FORMAT INTERNAL MEMORY	You must format the internal memory.	P.125
FORMAT CARD	The card is not formatted. Format the card with this camera.	P.124
CARD ERROR	Reformat the card. If, after doing so, the error message still appears, the card may be faulty. Do not use the card.	P.124
WRITING TO CARD	Writing file to memory. Wait until writing finishes.	-
NO FILE	There are no files that can be played back.	-
CANNOT RECORD	The number of remaining shots is 0. Switch to another card or the internal memory.	P.21
NO FILES TO RESTORE.	There are no files to restore.	P.112



Camera Troubleshooting

Power Supply

Problem	Cause	Solution	Refer to
The camera does not turn on.	Battery is not loaded or is exhausted.	Load the rechargeable battery correctly or charge the battery as required.	P.24 P.23
	A (manganese dry cell or other) unacceptable battery is used.	Use the dedicated rechargeable battery. Never use any other batteries.	P.20
	The camera is automatically turned off by auto power off.	Turn the camera back on.	P.26
	The battery is loaded in wrong direction.	Load correctly.	P.24
The camera turns off during use.	The camera was left unattended and unused, so auto power off turned it off.	Turn the camera back on.	P.26
	Battery is running low.	Charge the rechargeable battery.	P.23
	A (manganese dry cell or other) unacceptable battery is used.	Use the dedicated rechargeable battery. Never use any other batteries.	P.20
The camera does not turn off.	Camera malfunction.	Remove the battery and load it again.	P.24
The battery has been fully charged, but: <ul style="list-style-type: none"> The battery mark is displayed, indicating a low battery level. The camera turns off. 	A (manganese dry cell or other) unacceptable battery is used.	Use the dedicated rechargeable battery. Never use any other batteries.	P.20
Cannot charge the battery.	Battery has reached the end of its useful life.	Replace with a new rechargeable battery.	P.24
Battery runs out quickly.	It is being used at extreme high or low temperatures.	-	-
	Many shots are being taken in dark places or other location requiring extensive use of flash.	-	-

Shooting

Problem	Cause	Solution	Refer to
The camera does not shoot even if you press the shutter release button.	Battery is exhausted.	Charge the rechargeable battery.	P.23
	The camera is not on or it is not in the shooting mode.	Press the POWER button to turn the camera on or press the  (Playback) button to select the shooting mode.	P.26 P.46
	The camera is in playback mode.	Press the  (Playback) button to select the shooting mode.	-
	The shutter release button is not pressed all the way.	Press the shutter release button all the way.	P.31 P.32
	The SD memory card is not formatted.	Format the card.	P.124
	The SD memory card is full.	Load a new card, or delete unwanted files.	P.24 P.51
	The SD memory card has reached the end of its useful life.	Load a new SD memory card.	P.24
	The flash is charging.	Wait until the flash mode symbol stops blinking.	P.37
	The SD memory card is locked.	Unlock the card.	P.21
	The contact surface of the SD memory card is dirty.	Wipe with a soft, dry cloth.	-
Unable to view the shot image.	The image confirmation time is too short.	Lengthen the image confirmation time.	P.135
Images do not appear on the LCD monitor.	The camera is not on or the LCD monitor is dark.	Turn the camera on or adjust the brightness of the LCD monitor.	P.26 P.126
	The VIDEO/AV cable is connected.	Disconnect the VIDEO/AV cable.	P.113
	The screen display is in synchro-monitor mode.	Press the DISP. button to change the display.	P.55
Although the camera is set to auto focus, it is unable to focus.	The lens or AF window is dirty.	Wipe clean with a soft, dry cloth.	P.14
	The subject is not in the center of the shooting range.	Shoot with focus lock.	P.32
	It is a hard-to-focus subject.	Shoot with focus lock or manual focus.	P.32 P.69
The picture is blurred.	You moved the camera when pressing the shutter release button.	Hold the camera with your elbows pressed against your body. Use a tripod. Use the camera shake correction function.	P.29 P.93
	When shooting in a dark place (such as indoors), the shutter speed slows down and pictures become easily blurred.	Use the flash. Raise the ISO setting. Use the camera shake correction function.	P.37 P.90 P.93

Problem	Cause	Solution	Refer to
The flash does not fire or the flash cannot charge.	The flash cannot be used in the following cases: <ul style="list-style-type: none"> • When white balance bracket is set • In Multi-shot mode • In movie mode In scene modes, the flash is disabled by default.	To shoot with the flash, change the settings or mode.	P.37 P.79 P.73 P.96 P.182
	The flash is set to flash off.	Use the  (Flash) button to cancel flash off.	P.37
	Battery is running low.	Charge the rechargeable battery.	P.23
Even though the flash fired, the picture is dark.	The distance to the subject is greater than 2.0 meters in telephoto or greater than 3.0 meters in wide-angle.	Get closer to your subject and shoot.	P.37
	The subject is dark.	Correct the exposure. (Exposure compensation also changes the light intensity of the flash.)	P.86
The image is too bright.	The light intensity of the flash is not appropriate.	Move a little away from the subject or illuminate the subject with another light source instead of using the flash.	P.37
	Subject is overexposed.	Correct the exposure. Cancel exposure time.	P.86 P.81
	The brightness of the LCD monitor is not appropriate.	Adjust the brightness of the LCD monitor.	P.126
The image is too dark.	The shot was taken in a dark place while set to flash off.	Use the  (Flash) button to cancel flash off.	P.37
	The subject is underexposed.	Correct the exposure. Set to long exposure time.	P.86 P.81
	The brightness of the LCD monitor is not appropriate.	Adjust the brightness of the LCD monitor.	P.126
The image lacks natural color.	The picture was shot in conditions that made it difficult for auto white balance to adjust the white balance.	Add a white object to the composition or use a white balance setting other than auto.	P.87
The date or recording information does not appear on the screen.	The screen display function is set to no display.	Press the DISP. button to change the display.	P.55
The brightness of the LCD monitor changes during AF.	You are using AF in a dark place or when the auto focus range and surrounding brightness are different.	This is normal.	-
There is a vertical smear on the image.	This is a phenomenon that occurs when a bright subject is shot. It is called the smear phenomenon.	This is normal.	-

Playback/Deleting

Problem	Cause	Solution	Refer to
Cannot play back, or the playback screen does not appear.	The camera is not in playback mode.	Press the  (Playback) button.	P.46
	The VIDEO/AV cable is not connected properly.	Reconnect it properly.	P.113
	The VIDEO OUT MODE setting is incorrect.	Set it to the correct format.	P.148
The contents of the SD memory card cannot be played back, or the playback screen does not appear.	No SD memory card is loaded, or an SD memory card with no stored images is loaded.	Load a card with stored images.	P.24
	You played back an SD memory card that was not formatted with this device.	Load a card that was formatted and recorded with this device.	P.24 P.124
	You played back an SD memory card that was not recorded normally.	Load a normally recorded card.	-
	The contact surface of the SD memory card is dirty.	Wipe with a soft, dry cloth.	-
	There is something wrong with the SD memory card.	Play back images from another card and if there is nothing wrong with the card, the camera is okay. There may be something wrong with the card, so do not use it.	-
The LCD monitor turned off.	Battery is running low.	Charge the rechargeable battery.	P.23
	The camera was left unattended and unused, so auto power off turned it off.	Turn the camera back on.	P.26
A file cannot be deleted.	The file is protected.	Unprotect the file.	P.102
	The SD memory card is locked.	Unlock the card.	P.21
Cannot format the SD memory card.	The SD memory card is locked.	Unlock the card.	P.21

Other Problems

Problem	Cause	Solution	Refer to
Cannot load the SD memory card.	The card is facing the wrong way.	Load correctly.	P.24
The camera does not operate even when the buttons are pressed.	Battery is running low.	Charge the rechargeable battery.	P.23
	Camera malfunction.	Press the POWER button to turn the camera off, and then press the POWER button to turn the camera on again.	P.26
		Remove the battery and load it again.	P.24
The date is incorrect.	The correct date/time are not set.	Set the correct date/time.	P.146
The set date disappeared.	The battery was removed.	If the battery is removed for about one week, the date setting will be lost. Make the settings again.	P.146
Auto power off does not work.	Auto power off is set to [OFF].	Set the time for auto power off.	P.132
The beep sound cannot be heard.	The beep sound volume is turned off.	Use [VOL. SETTINGS] to set the volume to a setting other than mute.	P.134
Images do not appear on the TV.	The VIDEO OUT MODE setting is incorrect.	Set it to the correct format.	P.148
	The AV cable is not connected.	Connect the AV cable properly.	P.113
	The TV is not correctly set to VIDEO IN.	Check that the TV is correctly set to VIDEO IN.	-

Software and Computer Troubleshooting

For details about the software, refer to the “Software User Guide” (PDF file).

Warning Messages Under Windows XP Service Pack 2

When software for your Ricoh digital camera is used on a computer with Windows XP Service Pack 2 installed, the following warning message may appear at software activation or USB connection. With this in mind, refer to the following:

When this warning message is displayed:

- 1 Check the information provided on the message screen to make sure that it comes from a reputable source, and then click the [Unblock] button.



-  **Caution**-----
If you do not recognize the program, you should block it because it may be a virus. Click the [Keep Blocking] button to prevent the program from connecting to the Internet.

If you clicked the [Keep Blocking] button:

Follow the steps below to check the Windows Firewall settings.

- 1 Click [Start] and then [Control Panel].
- 2 Double-click [Windows Firewall].

- If [Windows Firewall] is not displayed, click [Switch to Classic View] at the top left of the window.



Windows
Firewall

- 3** Click the [Exceptions] tab.
- 4** Check that the software is in [Programs and Services].
- 5** Click the [Add Program] button to add software that uses the network.



If you clicked the [Ask Me Later] button:

Each time the program is activated, the [Windows Security Alert] dialog box appears. Then you can select [Unblock].

Specifications

General

Video Signal Format	NTSC, PAL
Power Source Voltage	Rechargeable Battery DB-70 (3.6 V) × 1
External Dimensions (W) × (H) × (D)	99.6 × 55.0 × 23.3 (20.6 at the thinnest part) mm (excluding projecting parts)
Weight	Camera: Approximately 135 g (excluding battery, strap) Accessories: Approximately 26 g (battery, strap)
Tripod Hole Shape	1/4-20UNC
Operating Temperature Range	0 °C to 40 °C
Operating Humidity Range	85% or less
Storage Temperature Range	-20 °C to 60 °C

Camera Parts

Image Pickup Element	Total 7.41 million pixels (effective pixels 7.24 million), 1/2.5" primary-color CCD
Lens	
Lens	7.1× Optical Zoom Aperture: F3.3 (Wide-angle) to 5.2 (Telephoto)
Focal Length	4.6 to 33 mm (equivalent to 28 to 200 mm on a 35mm camera)
Shooting Distance	Approximately 0.3 m to ∞ (Wide-angle) or 1.0 m to ∞ (Telephoto)
Macro Shooting Distance	Approximately 0.01 m to ∞ (Wide-angle), 0.25 m to ∞ (Telephoto) or 0.01 m to ∞ (Zoom macro mode)
Digital Zoom	4.8 times
Monitor Display Parts	
Screen Size	2.7"
Type	Transparent Amorphous Silicon TFT LCD
Pixel Count	Approx. 230,000
White Balance	AUTO/Fixed (OUTDOORS, CLOUDY, INCAND., INCAND.2, FLUORES., MANUAL)
Exposure Adjustment	
Light Metering Sensitivity Distribution	Multi Light Metering (256 segments), Center-weighted Light Metering, Spot Metering
Exposure Compensation	Manual exposure compensation +/-2.0EV (1/3EV Steps)
Metering Method	TTL-CCD Metering Method
Flash AE	Yes (In Daylight Synchro: On)
Shutter Speed	Still image: 8, 4, 2, 1 to 1/2000 seconds; Movie: 1/30 to 1/2000 seconds
ISO Sensitivity (Standard Output Sensitivity)	AUTO, AUTO-HI, ISO 64/ISO 100/ISO 200/ISO 400/ISO 800/ISO 1600

Distance Control	
AF Method	Normal Shooting: CCD method, Macro: CCD method
AF Measurement Range	Normal: approx. 0.3 m to ∞, Macro: approx. 0.01 m to ∞
Internal Flash	
Method	Flashmatic and pre-flash method
Shooting Distance	Approx. 0.2 to 3.0 m (Wide-angle), Approx. 0.25 to 2.0 m (Telephoto) (ISO: AUTO)
Operating Modes	Flash Off/Auto/Red-eye reduction/Forced Flash/Soft flash/Flash synchro
Date Maintain Time	Approx. 1 week

Image Data Record/Playback Part

Pixels	
Still Image	3072 × 2304, 3072 × 2048, 2592 × 1944, 2048 × 1536, 1280 × 960, 640 × 480
Text	3072 × 2304, 2048 × 1536
Movie	640 × 480, 320 × 240, 160 × 120
File Formats	
Still Image	JPEG (Exif Ver.2.21)
Text	JPEG (Exif Ver.2.21)
Movie	AVI (Open DML Motion JPEG Format Compliant)
Sound	WAV (Exif Ver.2.21 μ law)
Camera File System Standard	DCF ("Design rule for Camera File system", a JEITA standard)
Compression Format	JPEG Baseline Format Compliant (Still image, movie)
Image Size	
3072 × 2304	N: approx. 1478 KB/Screen, F: approx. 2567 KB/Screen
3072 × 2048	F: approx. 2284 KB/Screen
2592 × 1944	N: approx. 1060 KB/Screen, F: approx. 1835 KB/Screen
2048 × 1536	N: approx. 672 KB/Screen, F: approx. 1317 KB/Screen
1280 × 960	N: approx. 356 KB/Screen, F: approx. 686 KB/Screen
640 × 480	N: approx. 83 KB/Screen

I/O Terminals

Video Out	1.0 Vp-p (75T)
USB Terminal	USB2.0 High-Speed (Mini B cable)

Memory Cards for Recording and Playback

Memory Type	SD memory card, SDHC memory card, Multi media card
-------------	--

Number of Images That Can be Stored in Internal Memory/SD Memory Card

The following table shows the approximate number of images that can be recorded in the internal memory and onto an SD memory card at various image size and picture quality settings.

Mode	Picture Quality	Image Size	Internal Memory	64 MB	128 MB	256 MB	512 MB	1 GB	2 GB
Still Image	F	3072 × 2304	19	22	44	88	178	343	698
	N	3072 × 2304	34	37	76	152	308	592	1205
	F	3072 × 2048	22	24	49	99	200	385	778
	F	2592 × 1944	27	30	62	123	249	479	975
	N	2592 × 1944	47	53	107	213	430	828	1661
	F	2048 × 1536	38	43	87	173	349	671	1366
	N	2048 × 1536	74	83	169	338	682	1313	2671
	F	1280 × 960	70	78	158	317	640	1232	2457
	N	1280 × 960	133	147	300	599	1208	2323	4726
	N	640 × 480	580	644	1303	2598	5236	10071	20476
TEXT MODE		3072 × 2304	34	37	76	152	308	592	1205
		2048 × 1536	74	83	169	338	682	1313	2671
Movie	640 × 480 15FPS		51 s	57 s	1 min 56 s	3 min 51 s	7 min 46 s	14 min 57 s	30 min 24 s
	640 × 480 30FPS		26 s	28 s	58 s	1 min 56 s	3 min 55 s	7 min 31 s	15 min 19 s
	320 × 240 15FPS		2 min 40 s	2 min 58 s	5 min 59 s	11 min 57 s	24 min 5 s	46 min 19 s	94 min 11 s
	320 × 240 30FPS		1 min 22 s	1 min 31 s	3 min 4 s	6 min 7 s	12 min 19 s	23 min 42 s	48 min 13 s
	160 × 120 15FPS		9 min 23 s	10 min 25 s	21 min 3 s	41 min 58 s	84 min 33 s	162 min 36 s	330 min 42 s
	160 × 120 30FPS		5 min 6 s	5 min 40 s	11 min 27 s	22 min 50 s	46 min 1 s	88 min 31 s	180 min 2 s



Note

- The number of remaining shots displayed on the LCD monitor may differ from the actual number of shots, depending on the subject.
- Movie recording time and the maximum number of still pictures may vary depending on the capacity of the recording destination (internal memory or SD memory card), shooting conditions, and the type and manufacturer of the SD memory card.
- A high speed memory card is recommended when shooting for long periods.

Optional Accessories

The Caplio R6 can be used with the items (sold separately) listed below.

Item	Model	Remarks
Rechargeable Battery	DB-70	Rechargeable battery for use with this camera.
Battery Charger	BJ-7	Used to charge the rechargeable battery (DB-70).
Soft Case	SC-70	Used to store your camera.

Functions Whose Defaults are Restored When Camera is Turned Off

Turning the camera off may reset some function settings to their defaults.

The table below indicates whether or not the function is reset to its default when the camera is turned off.

O : setting is saved × : setting is restored

Menu	Function		Default Settings
SHTG STGS	PIC QUALITY/SIZE	O	N3072(7M)
	FOCUS	O	MULTI AF
	AE METERING	O	MULTI
	SHARPNESS	O	NORMAL
	CONT. MODE	×	OFF
	COLOR DEPTH	O	NORMAL
	AUTO BRACKET	×	OFF
	TIME EXPOSURE	O	OFF
	INTERVAL	×	0s
	IMAGE WITH SOUND	×	OFF
	DATE IMPRINT	O	OFF
	EXPOSURE COMP.	O	0.0
	WHITE BALANCE	O	AUTO
	ISO SETTING	O	AUTO
	SLOW SHUTTER LMT	O	1/8SEC.
	CAMERA SHAKE COR	O	ON
	Macro shooting	×	MACRO OFF
	Flash	O	FLASH OFF
	Self-timer	×	SELF-TIMER OFF
	Maximum brightness	O	-
	DENSITY (TEXT MODE)	O	NORMAL
	SIZE (TEXT MODE)	O	2048(3M)
	MOVIE SIZE (Movie Mode)	O	320
FRAME RATE	O	30FPS	
RECORD DUAL SIZE	O	OFF	
PLBK STGS	VOL. SETTINGS	O	-

O : setting is saved × : setting is restored

Menu	Function		Default Settings
SETUP	LCD BRIGHTNESS	O	-
	REG. MY SETTINGS	O	-
	STEP ZOOM	O	OFF
	ISO AUTO-HIGH	O	AUTO 400
	SUB FILE SIZE	O	320
	AUTO POWER OFF	O	1 MIN.
	BEEP SOUND	O	ALL
	VOL. SETTINGS	O	■ ■ □(Medium)
	LCD CONFIRM.	O	0.5 SEC.
	ADJ BTN. SET.1	O	EXPO.CMP
	ADJ BTN. SET.2		WHT.BAL.
	ADJ BTN. SET.3		ISO
	ADJ BTN. SET.4		OFF
	AF AUX. LIGHT	O	ON
	DIGITAL ZOOM IMG	O	NORMAL
	SHTG STGS WARNG.	O	ON
	ENLGE PHOTO ICON	O	OFF
	USB CONNECTION	O	MASS STR
	SEQUENTIAL NO.	O	OFF
	DATE SETTINGS	O	-
LANGUAGE/言語	O	*	
VIDEO OUT MODE	O	*	

* The default setting varies depending on where you purchased the camera.

About Scene Mode

Depending on the scene mode, the operation of functions may differ from when in normal shooting mode. Refer to the table below.

Scene Mode	Flash	Macro Shooting
PORTRAIT	Initial setting: FLASH OFF	Disabled
FACE	Initial setting: FLASH OFF	Disabled
SPORTS	Initial setting: FLASH OFF	Disabled
LANDSCAPE	Fixed to [FLASH OFF]	Disabled
NIGHTSCAPE	[FLASH ON] is disabled	Disabled
	Initial setting: AUTO	
HIGH SENS	Initial setting: FLASH OFF	Enabled
ZOOM MACRO	Initial setting: FLASH OFF	Macro shooting only
BLACK&WHITE	Initial setting: FLASH OFF	Enabled
SEPIA	Initial setting: FLASH OFF	Enabled
SKEW COR MODE	Initial setting: FLASH OFF	Enabled
TEXT MODE	Initial setting: FLASH OFF	Enabled
MOVIE	-	Enabled

Shooting Setting Menu Items by Scene Mode

Setting	PORTRAIT	FACE	SPORTS	LANDSCAPE	NIGHTSCAPE	HIGH SENSITIVITY	ZOOM MACRO	BLACK&WHITE	SEPIA	SKEW COR MODE	TEXT MODE	MOVIE	Refer to
PIC QUALITY/SIZE	O	O	O	O	O	O	O	O	O	O	-	O	P.66
DENSITY	-	-	-	-	-	-	-	-	-	-	O	-	P.61
SIZE	-	-	-	-	-	-	-	-	-	-	O	-	P.66
FRAME RATE	-	-	-	-	-	-	-	-	-	-	-	O	P.97
FOCUS	O	-	O	-	O	O	O	O	O	O	-	O	P.68
AE METERING	-	-	-	-	-	-	O	-	-	O	-	-	P.71
SHARPNESS	-	-	-	-	-	-	O	-	-	O	-	-	P.72
CONT. MODE	-	-	-	-	-	-	O	-	-	-	-	-	P.73
COLOR DEPTH	-	-	-	-	-	-	O	-	-	O	-	-	P.77
AUTO BRACKET	-	-	-	-	-	-	O	-	-	-	-	-	P.78
TIME EXPOSURE	-	-	-	-	-	-	O	-	-	-	-	-	P.81
IMAGE WITH SOUND	O	O	O	O	O	O	O	O	O	O	O	-	P.84
DATE IMPRINT	O	O	O	O	O	O	O	O	O	O	O	-	P.85
EXPOSURE COMP.	O	O	O	O	O	O	O	O	O	O	-	-	P.86
WHITE BALANCE	O	-	O	O	O	O	O	-	-	O	-	O	P.87
ISO SETTING	-	O	-	-	-	-	O	-	-	O	-	-	P.90
SLOW SHUTTER LMT	O	O	O	O	O	O	O	O	O	O	O	-	P.92
RECORD DUAL SIZE	O	O	O	O	O	O	O	O	O	-	O	-	P.94
CAMERA SHAKE COR	O	O	O	O	O	O	O	O	O	O	O	-	P.93

O Available, - Not available

For details about options, see P.63.

Using Your Camera Abroad

Warranty

This product was manufactured for use in the country in which it was purchased. The warranty is only valid in the country in which the camera was purchased.

Should the product fail or malfunction while you are abroad, the manufacturer assumes no responsibility for servicing the product locally or bearing the expenditure incurred therefore.

Playback on Television in Other Regions

Playback is possible on televisions (or monitors) equipped with a video input terminal. Please use the AV cable provided.

This camera is compatible with both NTSC and PAL television formats. Set the video format on the camera to match that of the television you are using.

When you go abroad, set your camera to the local video format.

Cautions on Use

Cautions on Use

- This product was manufactured for use in the country in which it was purchased. The warranty is only valid in the country in which the camera was purchased.
- Should the product fail or malfunction while you are abroad, the manufacturer assumes no responsibility for servicing the product locally or bearing the expenditure incurred therefore.
- Be sure not to drop or apply any sudden force to the camera.
- Firing the flash consecutively may heat the firing unit. Do not fire it consecutively more than necessary.
- Do not touch the flash and keep foreign objects away from the firing unit. Doing so can cause burns and fires.
- Do not fire the flash near eyes. It could cause visual impairment (particularly for infants).
- Do not fire the flash near the driver of a vehicle to avoid causing accidents.
- The batteries may become hot after extended use. Touching the batteries immediately after use could result in burns to your fingers.
- If the LCD monitor or panel is exposed to sunlight, they may become washed out and images may become hard to view.
- The LCD monitor and panel may contain some pixels that do not remain lit up continually in part or at all. Also, the brightness may become uneven because of the characteristics of LCDs. These are not failures.
- Do not forcefully press the surface of the LCD monitor.
- While you are carrying the camera, be careful not to hit it against other objects.
- In an environment where the temperature changes suddenly, condensation may occur in the camera, resulting in troubles such as fogging of the glass surface or malfunctions of the camera. If this occurs, place the camera in a bag to slow the temperature change as much as possible. Take it out of the bag after the temperature difference from the atmosphere has decreased to a fairly small amount.
- To avoid damaging the connectors, do not put any objects into the camera's microphone or speaker holes.



Conditions in which condensation may easily occur:-----

- When the camera is moved to an environment where the temperature differs greatly.
- In humid places.
- In a room immediately after being heated, or when the camera is exposed directly to cooled air from an air-conditioner or another similar appliance.

Care and Storage

Care

- Please note that if fingerprints, dirt, etc. get onto the lens, picture quality will suffer.
- When dust or dirt does get on the lens, do not touch it directly with your fingers, and either use a blower (available in stores) to blow it off, or a soft cloth to gently dust it off.
- After use at the beach or around chemicals, wipe it off particularly carefully.
- In the unlikely event that your camera fails to work properly, please consult your Ricoh Repair Center.
- There are high voltage circuits in this camera. As this is dangerous, do not dismantle this camera under any circumstances.
- Do not get volatile substances, such as thinner, benzene, or pesticides on your camera. This may cause a change in quality, paint to peel, etc.
- As the surface of the LCD monitor is easily scratched, do not rub hard objects against it.
- Clean the surface of the LCD monitor by wiping gently with a soft cloth containing a small amount of display cleaner sold in stores.

Use and Storage

- Please avoid using or storing your camera in the following kinds of places, as this may damage the camera.
 - In high heat and humidity, or where there is severe change in temperature or humidity.
 - Places with a lot of dust, dirt or sand.
 - Places with severe vibration.
 - Places where it is in direct contact with vinyl or rubber products or chemicals, including mothballs or other insect repellent, for long periods of time.
 - Places with strong magnetic fields (near a monitor, transformer, magnet, etc.).
- Remove the batteries if you are not going to use the camera for a long period of time.

Precautions regarding care of your camera

1. Be sure to turn the power off.
2. Remove the batteries before caring for your camera.

Warranty and Servicing

1. This product is backed by a limited warranty. During the warranty period mentioned in the Warranty supplied with your camera, any defective parts will be repaired free of charge. In the event of a camera malfunction, contact the dealer from which you purchased the camera or your nearest Ricoh Repair Center. Please note that you will not be reimbursed for the cost of bringing the camera to the Ricoh Repair Center.
2. This warranty does not cover any damage resulting from:
 - ① failure to follow the instructions in the instruction manual;
 - ② repair, modification or overhaul not conducted by an authorized service center listed in the instruction manual;
 - ③ fire, natural disaster, act of God, lightning, abnormal voltage, etc;
 - ④ improper storage (noted in the "Camera User Guide"), leaking of battery and other fluids, mold, or otherwise insufficient care of the camera.
 - ⑤ submergence in water (flooding), exposure to alcohol or other beverages, infiltration of sand or mud, physical shock, or dropping of the camera, or pressure on the camera, and other unnatural causes.
3. After the warranty period has passed, you will be liable for all repair fees, including those incurred at an authorized service center.
4. You will be liable for all repair fees, even within the warranty period, if the warranty card is not attached or if the distributor's name or the purchase date have been changed or are not indicated on the card.
5. Expenses for overhaul and thorough inspection by special request of the customer will be charged to the customer, whether or not they are incurred during the warranty period.
6. This warranty only applies to the camera and not to the accessories, such as the case and strap, nor does it apply to the battery and other consumables provided.
7. Any consequential damages arising from failure of the camera, such as expenses incurred in taking pictures or loss of expected profit, will not be reimbursed whether they occur during the warranty period or not.
8. The warranty is only valid in the country in which the camera was purchased.
 - * The above provisions refer to repairs offered free of charge, and do not limit your legal rights.
 - * The intention of the above provisions is also described in the warranty card provided with this camera.
9. Parts essential to the servicing of the camera (that is, components required to maintain the functions and quality of the camera) will be available for a period of five years after the camera is discontinued.
10. Please note that if the camera is seriously damaged by flooding, submergence, infiltration of sand or mud, violent shocks or dropping, it may not be repairable, and restoration to its original condition may be impossible.



Note

- Before sending the camera in for repair, check the battery and read the instruction manual again to ensure proper operation.
- Some repairs require a significant amount of time to be completed.
- When sending the camera to a service center, please include a note which describes the defective part and the problem as precisely as possible.
- Remove all accessories not related to the problem before sending the camera to the service center.
- Before taking any important pictures (such as at weddings, on trips abroad, etc.), test the camera to check operation and ensure proper functioning. We recommend that you keep this manual and spare battery on hand.
- This warranty does not apply to data stored on an SD memory card or in internal memory.

INFORMATION TO THE USER

USA FCC Part15 Class B

The equipment has been tested and found to comply with the limits for a Class B digital device, pursuant to part 15 of the FCC Rules. These limits are designed to provide reasonable protection against harmful interference in a residential installation. This equipment generates, uses, and can radiate radio frequency energy and if not installed and used in accordance with the instructions, may cause harmful interference to radio communications. However, there is no guarantee that interference will not occur in a particular installation. If this equipment does cause harmful interference to radio or television reception, which can be determined by turning the equipment off and on, then user is encouraged to try to correct the interference by one or more of the following measures:

- Reorient or relocate the receiving antenna.
- Increase the separation between the equipment and receiver.
- Connect the equipment to an outlet on a circuit different from that to which the receiver is connected.
- Consult the dealer or an experienced radio/TV technician for help. (FCC 15.105B)

Changes or modifications not expressly approved by the party responsible for compliance could void the user's authority to operate the equipment. (FCC 15.21)

Properly shielded and grounded cables and connectors must be used for connection to a host computer in order to comply with FCC emission limits. (FCC 15.27)

COMPLIANCE INFORMATION STATEMENT

Product Name: DIGITAL CAMERA

Model Number: Caplio R6

This device complies with Part 15 of the FCC Rules.

Operation is subject to the following two conditions:

- (1) This device may cause harmful interference, and
- (2) This device must accept any interference received, including interference that may cause undesired operation.

RICOH CORPORATION

5 Dedrick Place, West Caldwell NJ, 07006 Tel.: 1-800-225-1899

Note to Users in Canada

Note: This Class B digital apparatus complies with Canadian ICES-003

Remarque Concernant les Utilisateurs au Canada

Avertissement : Cet appareil numérique de la classe B est conforme à la norme NMB-003 du Canada

IMPORTANT SAFETY INSTRUCTIONS-SAVE THESE INSTRUCTIONS
DANGER-TO REDUCE THE RISK OF FIRE OR ELECTRIC SHOCK, CAREFULLY
FOLLOW THESE INSTRUCTIONS.

Index

A

Acrobat Reader 157
ADJ BTN. SET.1, 2, 3, 4 136
ADJ. Button 15, 60, 99
AE METERING 71
AF AUX. LIGHT 137
AF Auxiliary Light/Self-Timer Lamp
..... 14
AF target shift 62
AUTO BRACKET 78
Auto Focus (AF) 68
AUTO POWER OFF 26, 132
AUTO RSZ 138
Auto Shooting Mode 16, 31
AV Cable 12, 113
AV Output Terminal 15, 113
AVI file 96

B

B&W 39
Backlighting 86
Battery 20
Battery Charger 12, 23
Battery Level Indication 19
Battery/Card Cover 15, 24
BEEP SOUND 133

C

Camera shake 30, 93
CAMERA SHAKE COR 93
Caplio Software CD-ROM
..... 13, 150
Card Reader 162
Charging 23
COLOR DEPTH 77
CONT. 73
COPY TO CARD 109

D

DATE IMPRINT 85
DATE SETTINGS 28, 146
Delete 51

Delete/Self-timer Button... 15, 44, 51
DENSITY 61
DeskTopBinder Lite 151, 155
Digital Zoom 35
DIGITAL ZOOM IMG 138
Direct Print 115
DISP. Button 15, 55
DPOF 105

E

Enlarged View 50
ENLGE PHOTO ICON 141
Error Messages 168
EXPOSURE COMP. 86

F

FACE 39, 41
Flash 14, 37, 44
Flash Button 15, 37
FOCUS 68
Focus Lock 32
FORMAT [CARD] 124
FORMAT [INT. MEM.] 125
FRAME RATE 97
Full-press 31

G

Grid Guide 55

H

Half-press 32
Handstrap 12
HIGH SENSITIVITY 39
Histogram 57

I

IMAGE WITH SOUND 84
Internal Memory 21, 47
INTERVAL 82
Irodio Photo & Video Studio
..... 150, 151, 159
ISO AUTO-HIGH 130
ISO SETTING 90

L

LANDSCAPE 39

LANGUAGE/言語	27, 147
LCD BRIGHTNESS	126
LCD CONFIRM.	135
LCD Monitor	15, 17
Lens.....	14
Lens Cover	14

M

M (Memory-reversal)-CONT	73
Macro Button	15, 36
Manual Focus (MF)	69
Mass Storage Mode (MASS STR)	161
MENU/OK Button ..	15, 65, 100, 122
Microphone	14
MODE Button	15, 40
Mode Selector	15, 16
MOVIE	40, 96
MOVIE SIZE	66
My Settings (MY).....	16, 38

N

NIGHTSCAPE	39
Number of images that can be stored	178
Number of shots you can take.....	20

O

ORIGINAL	142
----------------	-----

P

PIC QUALITY/SIZE	66
PictBridge	115
Playback Button	15, 46
Playback Mode	26, 46
Playback Setting menu.....	100
PORTRAIT	39
POWER Button	14
Printing	115
PROTECT	102

Q

Quick Review Button	15, 45
---------------------------	--------

R

Rechargeable Battery	12, 20, 23, 24
RECORD DUAL SIZE	94
RECOVER FILE.....	112
REG. MY SETTINGS	127
REPORT PRINT	118
RESIZE	108
RESTORE DEFAULTS	95
RICOH Gate La.....	150, 163

S

S (Stream)-CONT	73
Scene Mode (SCENE)	16, 39
SD Memory Card	21, 24, 47
SDHC Memory Card	22
Self-Timer	44
SEPIA	39
SEQUENTIAL NO.	144
SETUP menu	121
SHARPNESS	72
Shooting Setting Menu.....	63
SHTG STGS WARNG.	140
Shutter Release Button.....	14, 29
SKEW COR MODE.....	40, 42
SKEW CORRECTION	110
SLIDE SHOW	101
SLOW SHUTTER LMT	92
SPORTS	39
STEP ZOOM.....	129
Still Image Mode	17, 18, 39
SUB FILE SIZE	131
Synchro-Monitor Mode.....	55

T

TEXT MODE	40
Three-frame View	48
Thumbnail Display	48
TIME EXPOSURE	81
Tripod Screw Hole	15

U

USB Cable	12, 115
USB CONNECTION	142
USB Driver	150, 151

USB Terminal 15, 116, 160

V

VIDEO OUT MODE 148

VOL. SETTINGS 134

W

WHITE BALANCE 87

White Balance Bracket

(WB-BKT) 79

White Saturation Highlight Display
..... 56

WIA Driver 150, 151

Z

Zoom 35

Zoom Lever 15, 35

ZOOM MACRO 39, 43

Telephone Support Numbers in Europe

UK	(from within the UK) (from outside of the UK)	02073 656 580 +44 2073 656 580
Deutschland	(innerhalb Deutschlands) (außerhalb Deutschlands)	06331 268 438 +49 6331 268 438
France	(à partir de la France) (en dehors de la France)	0800 91 4897 +49 6331 268 409
Italia	(dall'Italia) (dall'estero)	02 696 33 451 +39 02 696 33 451
España	(desde España) (desde fuera de España)	91 406 9148 +34 91 406 9148

<http://www.service.ricohpmmc.com/>

From environmental friendliness to environmental conservation and to environmental management

Ricoh is aggressively promoting environment-friendly activities and also environment conservation activities to solve the great subject of management as one of the citizens on our precious earth.

To reduce the environmental loads of digital cameras, Ricoh is also trying to solve the great subjects of "Saving energy by reducing power consumption" and "Reducing environment-affecting chemical substances contained in products".



If a problem arises

First of all, see "Troubleshooting" (👉 P.168) in this manual. If the issues still persist, please contact a Ricoh office.

Ricoh Offices	
RICOH COMPANY, LTD.	3-2-3, Shin-Yokohama Kouhoku-ku, Yokohama City, Kanagawa 222-8530, Japan http://www.ricoh.co.jp/r_dc
RICOH AMERICAS CORPORATION	5 Dedrick Place, West Caldwell, New Jersey 07006, U.S.A. 1-800-22RICOH http://www.ricoh-usa.com
RICOH INTERNATIONAL B.V. (EPMCC)	Oberrather Str. 6, 40472 Düsseldorf, GERMANY (innerhalb Deutschlands) 06331 268 438 (außerhalb Deutschlands) +49 6331 268 438 http://www.ricohpmmc.com
RICOH UK LTD. (PMMC UK)	(from within the UK) 02073 656 580 (from outside of the UK) +44 2073 656 580
RICOH FRANCE S.A.S. (PMMC FRANCE)	(à partir de la France) 0800 91 4897 (en dehors de la France) +49 6331 268 409
RICOH ESPANA, S.A. (PMMC SPAIN)	(desde España) 91 406 9148 (desde fuera de España) +34 91 406 9148
RICOH ITALIA S.p.A. (PMMC ITALY)	(dall'Italia) 02 696 33 451 (dall'estero) +39 02 696 33 451
RICOH HONG KONG LIMITED	12/F, One Kowloon, 1 Wang Yuen Street, Kowloon Bay, Hong Kong
RICOH AUSTRALIA PTY. LTD.	8 Rodborough Road, Frenchs Forest, NSW 2086, Australia http://www.ricoh.com.au
About Irodio Photo & Video Studio	
North America (U.S.)	(Toll Free) +1-800-458-4029
Europe	UK, Germany, France and Spain: (Toll Free) +800-1532-4865 Other Countries: +44-1489-564-764
Asia	+63-2-438-0090
China	+86-21-5450-0391
Business hours: 9:00 AM to 5:00 PM	

Ricoh Company, Ltd.
Ricoh Building, 8-13-1, Ginza, Chuo-ku, Tokyo
104-8222, Japan
2007 June

En EN (USA) GB (GB) AE (AE)
Printed in China



* L 7 4 0 2 9 7 1 C *